



FMA110 User Manual

V1.06

*This version is suitable for device with universal firmware version
01.24.xx

Table of contents

1	INTRODUCTION	7
1.1	ATTENTION	7
1.2	INSTRUCTIONS OF SAFETY	7
1.3	LEGAL NOTICE	8
1.4	ABOUT DOCUMENT	8
2	BASIC DESCRIPTION	8
2.1	PACKAGE CONTENTS	8
2.2	BASIC CHARACTERISTICS	8
2.3	ELECTRICAL CHARACTERISTICS	11
2.4	ABSOLUTE MAXIMUM RATINGS	12
3	CONNECTION, PINOUT, ACCESSORIES	13
3.1	HOW TO INSERT SIM CARD INTO FMA110 DEVICE:	13
3.2	INSTALLING FMA110 DRIVERS	14
3.2.1	<i>System requirements for FMxxxx configurator</i>	14
3.2.2	<i>Drivers</i>	14
3.2.3	<i>Installing drivers</i>	15
3.3	NAVIGATE LED	16
3.4	STATUS LED	16
3.5	SOCKET 2×5	16
3.6	USB	17
3.7	ACCESSORIES	17
4	FIRMWARE	20
4.1	UPDATING FIRMWARE USING USB CABLE	20
5	OPERATIONAL BASICS	22
5.1	OPERATIONAL PRINCIPALS	22
5.2	SLEEP MODES	22
5.2.1	<i>Sleep mode</i>	22
5.2.2	<i>Deep Sleep mode</i>	22
5.3	VIRTUAL ODOMETER	23
5.4	FEATURES	23
5.4.1	<i>Scenarios</i>	23
5.4.2	<i>Trip</i>	24
5.4.3	<i>Geofencing</i>	25
5.4.4	<i>iButton list</i>	25
5.5	CONFIGURATION	25
5.6	CONFIGURATOR	25
5.7	RECORD STORAGE	28
5.8	SYSTEM SETTINGS	28
5.9	RECORDS SETTINGS	29
5.10	GSM SETTINGS, GPRS PART	30
5.11	GSM SETTINGS, SMS PART	30
5.12	GSM SETTINGS, OPERATOR LIST	32
5.13	DATA ACQUISITION MODE SETTINGS	33
5.14	FEATURES SETTINGS	38
5.14.1	<i>Scenarios settings</i>	38
5.14.2	<i>Trip settings</i>	39
5.14.3	<i>Geofencing settings</i>	41
5.14.4	<i>SMS events</i>	44
5.14.4.1	<i>SMS events configuration</i>	46
5.15	I/O SETTINGS	49
5.15.1	<i>Monitoring</i>	52
5.15.2	<i>Event Generating</i>	52

5.15.3	Hysteresis	52
6	SMS COMMAND LIST	53
6.1	SMS COMMAND LIST.....	53
6.1.1	getstatus.....	54
6.1.2	getweektime.....	55
6.1.3	getops.....	55
6.1.4	getcfgtime	55
6.1.5	getgps.....	55
6.1.6	getver	55
6.1.7	getinfo	56
6.1.8	getio.....	56
6.1.9	radio #.....	56
6.1.10	setdigout ## Y1 Y2	57
6.1.11	setdigoutX Z Y.....	57
6.1.12	getparam #####	57
6.1.13	setparam #####.....	57
6.1.14	getparam 1271 X/212 X	57
6.1.15	setparam 1271 X/212 X.....	57
6.1.16	readops #.....	57
6.1.17	flush #,#,#,#,#,#	57
6.1.18	sn #	58
6.1.19	banlist.....	58
6.1.20	crashlog	58
6.1.21	lvcانgetprog.....	58
6.1.22	lvcانsetprog #	58
6.1.23	lvcانgetinfo.....	59
7	DEBUG MODE	59
8	PARAMETER LIST	60
8.1	PARAMETERS VALUE TYPES.....	60
8.2	SYSTEM PARAMETERS	60
8.2.1	Sleep Mode (ID=1000)	60
8.2.2	Sleep timeout (ID=200).....	60
8.2.3	Analog Input value range (ID=1001)	60
8.2.4	Stop Detection Source (ID=1002).....	60
8.2.5	Static Navigation (ID=1003)	61
8.2.6	Ignition source (ID=1004)	61
8.2.7	Power Voltage High Level (ID=1005)	61
8.2.8	Power Voltage Low Level (ID=1006).....	61
8.2.9	Saving/Sending without time synchronization (ID=201)	61
8.2.10	GNSS System (ID=202).....	61
8.2.11	GNSS fix Timeout (ID=1007)	62
8.2.12	NTP Time Synchronization (ID=1008)	62
8.3	RECORDS PARAMETERS	62
8.3.1	8.3.1 Sorting (ID=1010).....	62
8.3.2	8.3.2 Active Data Link Timeout (ID=1011).....	62
8.3.3	8.3.3 Server Response Timeout (ID=1012).....	62
8.4	GSM PARAMETERS	63
8.4.1	GPRS content activation (ID=1240).....	63
8.4.2	APN Name (ID=1242).....	63
8.4.3	APN username (ID=1243)	63
8.4.4	APN Password (ID=1244).....	63
8.4.5	Domain (ID=1245)	64
8.4.6	Target Server Port (ID=1246).....	64
8.4.7	Protocol (ID=1247).....	64
8.4.8	Always online (ID=1248).....	64

8.4.9	SMS Login (ID=1252)	64
8.4.10	SMS Password (ID=1253)	65
8.4.11	SMS data sending settings (ID=1250)	65
8.4.12	SMS Data send week time schedule (ID=1273)	65
8.4.13	Authorized phone numbers (ID=1260-1270)	65
8.4.14	SMS Event PreDefined Numbers (ID=150-159)	65
8.4.15	Operator List (ID=1271 X)	65
8.4.16	Black Operator list (ID= 1272 X)	66
8.5	DATA ACQUISITION MODES PARAMETERS	66
8.5.1	Home Network GSM operator code "Vehicle on STOP" parameters	66
8.5.2	Min Period (ID=1540)	66
8.5.3	Min Saved Records (ID=1543)	66
8.5.4	Send Period (ID=1544)	66
8.5.5	GPRS Week Time (ID=1545)	67
8.5.6	Home Network GSM operator code "Vehicle MOVING" parameters	67
8.5.6.1	Min Period (ID=1550)	67
8.5.6.2	Min Distance (ID=1551)	67
8.5.6.3	Min Angle (ID=1552)	68
8.5.6.4	Min Saved Records (ID=1553)	68
8.5.6.5	Send Period (ID=1554)	68
8.5.6.6	GPRS Week Time (ID=1555)	68
8.5.6.7	Min Speed (ID=1556)	68
8.5.6.8	Min Speed Source (ID=1557)	69
8.5.7	Roaming Network GSM operator code "Vehicle on STOP" parameters	69
8.5.7.1	Min Period (ID=1560)	69
8.5.7.2	Min Saved Records (ID=1563)	69
8.5.7.3	Send Period (ID=1564)	69
8.5.7.4	GPRS Week Time (ID=1565)	69
8.5.8	Roaming Network GSM operator code "Vehicle MOVING" parameters	69
8.5.8.1	Min Period (ID=1570)	69
8.5.8.2	Min Distance (ID=1571)	70
8.5.8.4	Min Angle (ID=1572)	70
8.5.8.5	Min Saved Records (ID=1573)	70
8.5.8.6	Send Period (ID=1574)	70
8.5.8.7	GPRS Week Time (ID=1575)	71
8.5.8.8	Min Speed (ID=1576)	71
8.5.8.9	Min Speed Source (ID=1577)	71
8.5.9	Unknown Network GSM operator code "Vehicle on STOP" parameters	71
8.5.9.1	Min Period (ID=1580)	71
8.5.9.2	Min Saved Records (ID=1583)	71
8.5.9.3	Send Period (ID=1584)	71
8.5.9.4	GPRS Week Time (ID=1585)	72
8.5.10	Unknown Network GSM operator code "Vehicle MOVING" parameters	72
8.5.10.1	Min Period (ID=1590)	72
8.5.10.2	Min Distance (ID=1591)	72
8.5.10.3	Min Angle (ID=1592)	72
8.5.10.4	Min Saved Records (ID=1593)	72
8.5.10.5	Send Period (ID=1594)	73
8.5.10.6	GPRS Week Time (ID=1595)	73
8.5.10.7	Min Speed (ID=1596)	73
8.5.10.8	Min Speed Source (ID=1597)	73
8.6	FEATURES PARAMETERS	73
8.6.1	Green driving scenario (ID=1890)	73
8.6.2	Green Driving digital output control (ID=1891)	74
8.6.3	Max Acceleration Force (ID=1892)	74
8.6.4	Max Braking Force (ID=1893)	74
8.6.5	Max Cornering Force (ID=1894)	74
8.6.6	Overspeeding scenario (ID=1895)	74
8.6.7	Over Speeding digital output control (ID=1896)	74
8.6.8	Max allowed speed (ID=1897)	75
8.6.9	Jamming scenario (ID=1898)	75

8.6.10	Jamming digital output control (ID=1899)	75
8.6.11	Jamming sensitivity (ID=1900).....	75
8.6.12	Jamming Timeout (ID=1901)	75
8.6.13	Jamming Pulse duration (ID=1902)	75
8.6.14	Immobilizer scenario (ID=1903).....	76
8.6.15	Immobilizer digital output control (ID=1904)	76
8.6.16	iButton list checking (ID=1905).....	76
8.6.17	Trip (ID=1280).....	76
8.6.18	Start Speed (ID=1281).....	76
8.6.19	Ignition Off Timeout (ID=1282).....	76
8.6.20	Trip Continuous distance counting (ID=1283)	76
8.6.21	Remember iButton ID (ID=1284)	77
8.6.22	Odometer value (ID=1285)	77
8.6.23	Geofencing.....	77
8.6.23.1	Frame border (ID=1020).....	77
8.6.23.2	Geofence Zone #1 Shape (ID=1030)	77
8.6.23.3	Geofence Zone #1 Priority (ID=1031).....	77
8.6.23.4	Geofence Zone #1 Generate Event (ID=1032).....	78
8.6.23.5	Geofence Zone #1 Longitude (X1) (ID=1033)	78
8.6.23.6	Geofence Zone #1 Latitude (Y1) (ID=1034)	78
8.6.23.7	Geofence Zone #1 Longitude (X2) (ID=1035)	78
8.6.23.8	Geofence Zone #1 Latitude (Y2) (ID=1036)	78
8.6.24	AutoGeofencing.....	79
8.6.24.1	Enable/Disable (ID=1101).....	79
8.6.24.2	Activation Timeout (ID=1102)	79
8.6.24.3	Deactivate by (ID=1100).....	79
8.6.24.4	AutoGeofence event Priority (ID=1103).....	79
8.6.24.5	AutoGeofence event generating (ID=1104).....	79
8.6.24.6	Radius (ID=1105)	80
8.6.25	iButton List (ID=1610-1659).....	80
8.7	I/O PARAMETERS.....	80
8.7.1	I/O#1 property parameter (ID=1300)	80
8.7.2	I/O#1 priority (ID=1301)	80
8.7.3	I/O#1 High level (ID=1302)	81
8.7.4	I/O#1 Low level (ID=1303)	81
8.7.5	I/O#1 logic operand (ID=1304)	81
8.7.6	I/O#1 averaging length (ID=1305).....	81
	SMS EVENT CONFIGURATION	83
8.7.7	I/O#1 element SMS event configuration (ID=100).....	83
8.8	LV-CAN PARAMETERS.....	87
8.8.1	LVCAN mode (ID=1600)	87
8.8.2	Send data with 0, if ignition is off (ID=1601)	87
9	FMA110 WITH LV-CAN200 AND ALL-CAN300 CAN ADAPTERS	87
9.1	PURPOSE OF CAN ADAPTERS LV-CAN200 AND ALL-CAN300	87
9.2	LV-CAN200 AND ALL-CAN300 PROGRAM NUMBER SELECTION	88
9.2.1	LV-CAN200 and ALL-CAN300 program number configuration via SMS command.	88
9.2.2	Selecting LV-CAN200 and ALL-CAN300 program number manually	88
9.3	SIMPLE-CAN - CONTACTLESS CAN-BUS READER.....	89
9.4	CONNECTING FMA110 CAN ADAPTERS ALL-CAN300 AND LV-CAN200	90
9.5	FM11 CONFIGURATION.....	92
	PARAMETERS ID.....	95
9.6	SMS CONFIGURATION	101
9.7	CAN PROGRAM NUMBER REQUEST BY SMS	103
9.8	GET CAN INFO BY SMS	103
9.9	CLEAR COUNTED PARAMETERS VALUE	103
10	MOUNTING RECOMMENDATIONS	105
10.1	CONNECTING WIRES.....	105

10.2	CONNECTING POWER SOURCE.....	105
10.3	CONNECTING IGNITION WIRE.....	105
10.4	CONNECTING GROUND WIRE.....	105
10.5	MODULE INSTALLATION	106
11	CHANGE LOG	107

1 INTRODUCTION

1.1 Attention



Do not disassemble the device. If the device is damaged, the power supply cables are not isolated or the isolation is damaged, before unplugging the power supply, do not touch the device.



All wireless data transferring devices produce interference that may affect other devices which are placed nearby.



The device must be connected only by qualified personnel.



The device must be firmly fastened in the predefined location.



The programming must be performed using a second class PC (with autonomic power supply).



The device is susceptible to water and humidity.



Any installation and/or handling during a lightning storm are prohibited.



FMA110 has USB interface;
Please use cables provided with FMA110 device.
Teltonika is not responsible for any harm caused by using wrong cables for PC <-> FMA110 connection.

1.2 Instructions of safety

This chapter contains information on how to operate FMA110 safely. By following these requirements and recommendations, you will avoid dangerous situations. You must read these instructions carefully and follow them strictly before operating the device!

The device uses a 10 V...30 V DC power supply. The nominal voltage is 12 V DC. The allowed range of voltage is 10 V...30 V DC.

To avoid mechanical damage, it is advised to transport the FMA110 device in an impact-proof package. Before usage, the device should be placed so that its LED indicators are visible, which show the status of operation the device is in.

When connecting the connection (2x5) cables to the vehicle, the appropriate jumpers of the power supply of the vehicle should be disconnected.

Before dismounting the device from the vehicle, the 2x5 connection must be disconnected.

The device is designed to be mounted in a zone of limited access, which is inaccessible for the operator. All related devices must meet the requirements of standard EN 60950-1.

The device FMA110 is not designed as a navigational device for boats.

1.3 Legal Notice

Copyright © 2014 Teltonika. All rights reserved. Reproduction, transfer, distribution or storage of part or all of the contents in this document in any form without the prior written permission of Teltonika is prohibited.

Other products and company names mentioned here may be trademarks or trade names of their respective owners.

The manufacturer reserves the right to make changes and/or improvements at any time in design, functionality, parameters and electrical characteristics without any prior notice and without incurring obligations.

1.4 About document

This document contains information about the architecture, possibilities, mechanical characteristics, and configuration of the FMA110 device.

Acronyms and terms used in document

PC – Personal Computer.

GPRS – General Packet Radio Service

GPS – Global Positioning System

GSM – Global System for Mobile Communications

SMS – Short Message Service

AC/DC – Alternating Current/Direct Current

I/O – Input/Output

Record – AVL data stored in FMA110 memory. AVL data contains GPS and I/O information

AVL packet - data packet that is being sent to server during data transmission. AVL packet contains from 1 to 50 records.

2 BASIC DESCRIPTION

FMA110 is a terminal with GPS and GSM connectivity, which is able to determine the object's coordinates and transfer them via the GSM network. This device is perfectly suitable for applications, which need location acquirement of remote objects. It is important to mention that FMA110 has additional inputs and outputs, which let you control and monitor other devices on remote objects. FMA110 also has a USB port for device status log output and entering configurations.

2.1 Package contents¹

The FMA110 device is supplied to the customer in a cardboard box containing all the equipment that is necessary for operation. The package contains:

FMA110 device;

Input and output power supply cable with a 2x5 connection pins;

USB cable;

A card containing URL to download FMA110 device drivers and Configurator software.

2.2 Basic characteristics

GSM / GPRS features:

¹ Package content depends on Order Code, and can be customized by customer needs.

- Quad band supported (GSM 850 / 900 / 1800 / 1900 MHz);
- GPRS Multi-Slot Class 12(up to 240 kbps);
- GPRS Mobile Station Class B;
- SMS (text, data).

GNSS features:

- Tracking: 33/ 99 acquisition channels;
- Up to -165 dBm sensitivity;
- Hot start < 1s;
- Warm start < 25s;
- Cold start < 35s;
- NMEA -183 protocol;
- GPS, GLONASS, GALILEO, BEIDOU, SBAS, QZSS, DGPS, AGPS;
- Accuracy < 3m.

Hardware features:

- Cortex[®]-M3 processor;
- 1 MB internal Flash memory;
- Built-in accelerometer.

Interface features:

- Power supply: 10 ÷ 30V;
- USB port;
- 3 digital inputs;
- 1 analog input;
- 2 open collector digital outputs;
- 1Wire[®] temperature sensor
- 1Wire[®] iButton
- LEDs indicating device status.

Special features:

- Any element event triggers (external sensor, input, speed, temperature, etc.);
- Highly configurable data acquisition and sending;
- Multiple Geo-fence areas;
- Sleep mode;
- Deep sleep mode;
- Configurable scenarios available;
- Real-time process monitoring;
- Authorized number list for remote access;
- Firmware update over GPRS or USB port;
- Configuration update over GPRS, SMS or USB port;
- TCP/IP or UDP/IP protocol support;
- 3500 records storing.

Overvoltage protection (new devices with order code FMA110 Vxxxxx):

Description	Voltage	Duration
Normal operation	10-30V	Unlimited
Protection turns on, device turns off.	34V	Unlimited
Maximum voltage	<70V	Unlimited
Maximum voltage impulse	90V	5 mili seconds

Technical features

Part name	Physical specification
Navigation LED	LED
Modem LED	LED
Socket 2x5	Tyco Micro MATE-N-LOK™ 4-794628-0 or similar
USB	Mini USB socket

Table 1. FMA110 specifications

Technical details
Power supply 10...30 V DC 2W Max Energy consumption ¹ : GPRS: --- 120 mA r.m.s Max., Nominal: --- average 65 mA r.m.s, Deep Sleep: --- average less than 5 mA ² Operation temperature: -25°C ... +55°C Storage temperature: -40°C ... +70°C Storage relative humidity 5 ... 95 % (no condensation) Internal fuse: 3A, 125V

¹ Energy consumption has been tested at 12V voltage with no battery charging.

² When in Deep Sleep mode no data storing and sending is activated.

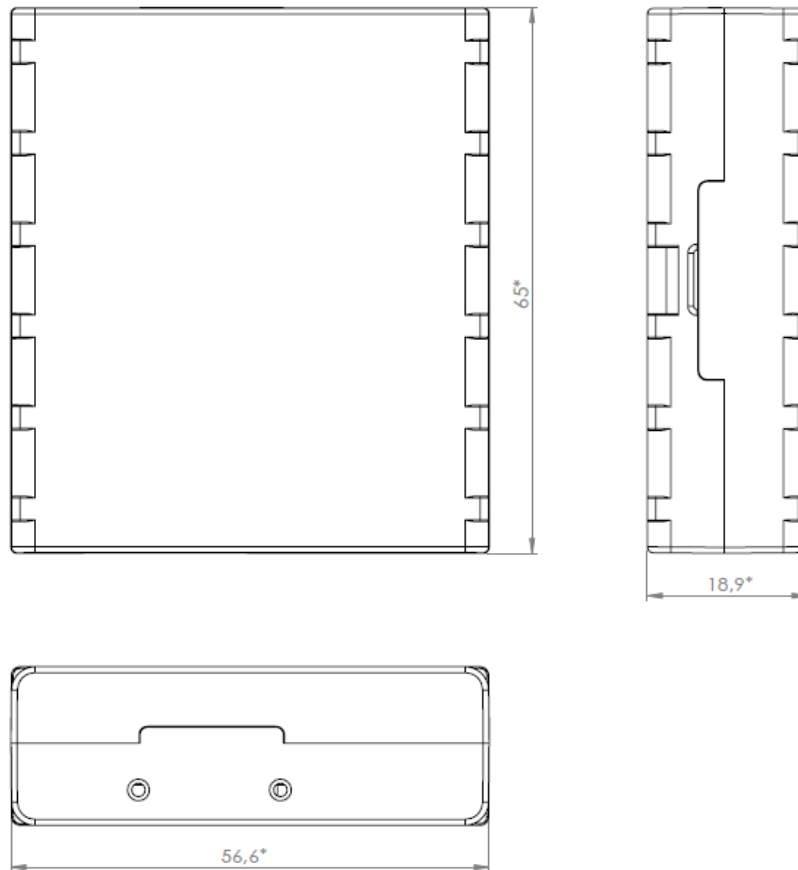

Figure 1 FMA110 view & dimensions (tolerance $\pm 2\text{mm}$)

2.3 Electrical characteristics

CHARACTERISTIC DESCRIPTION	VALUE	Min.	Typ.	Max.	Unit
Supply Voltage:					
Supply Voltage (Recommended Operating Conditions)		10		30	V
Digital Output (Open Drain grade):					
Drain current (Digital Output OFF)				120	μA
Drain current (Digital Output ON, Recommended Operating Conditions)				300	mA
Static Drain-Source resistance (Digital Output ON)				300	mOhm
Digital Input:					
Input resistance (DIN1, DIN2, DIN3)		15			kOhm
Input Voltage (Recommended Operating Conditions)		0		Supply voltage	V
Input Voltage threshold (DIN1)			7,5		V
Input Voltage threshold (DIN2, DIN3)			2,5		V

Analog Input:				
Input Voltage (Recommended Operating Conditions), Range1	0		10	V
Input resistance, Range1		120		kOhm
Measurement error		1,43		%
Additional error		±12		mV
Input Voltage (Recommended Operating Conditions) Range2	0		30	V
Input resistance, Range2		146,7		kOhm
Measurement error		1,75		%
Additional error		±36		mV
Output Supply Voltage 1-Wire:¹				
Supply Voltage	3,3		3,6	V
Output inner resistance		7		Ohm
Output current ($U_{out} > 3.0V$)		30		mA
Short circuit current ($U_{out} = 0$)		130		mA



Note: Analog Input error margin can increase if temperature varies. If Analog input is not connected FMA110 will still measure certain numbers and it cannot be 0. This measurement is influenced by hardware components.

2.4 Absolute Maximum Ratings

CHARACTERISTIC DESCRIPTION	VALUE				Unit
	Min.	Typ.	Max.		
Supply Voltage (Absolute Maximum Ratings)	-32		32		V
Drain-Source clamp threshold voltage (Absolute Maximum Ratings), ($I_{drain} = 2mA$)			36		V
Digital Input Voltage (Absolute Maximum Ratings)	-32		32		V
Analog Input Voltage (Absolute Maximum Ratings)	-32		32		V

¹ 1-wire Supply voltage PIN is dedicated for 1-wire devices ONLY, do not use it for any other purpose.

3 CONNECTION, PINOUT, ACCESSORIES

3.1 How to insert SIM card into FMA110 device:

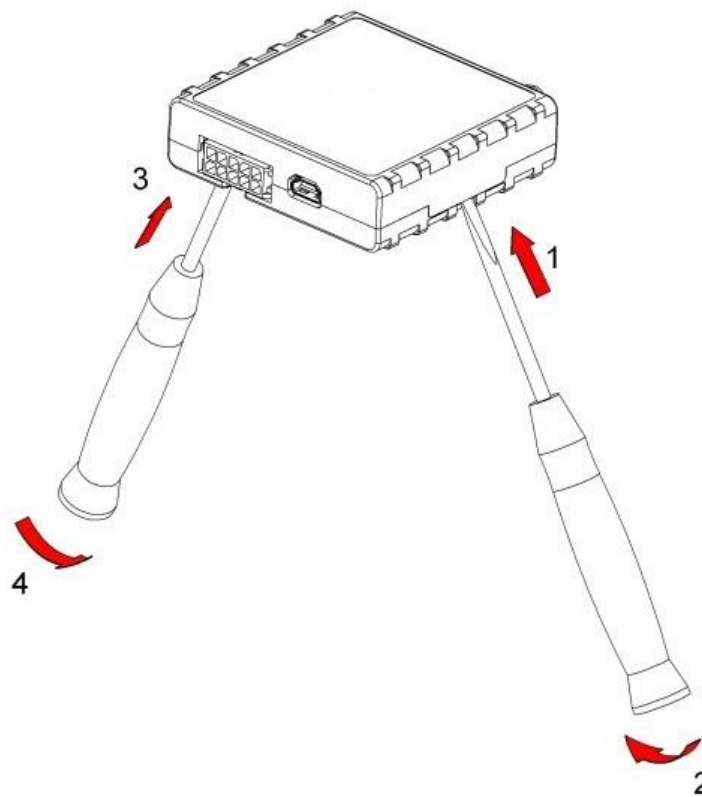

①

Gently open FMA110 case using screwdrivers

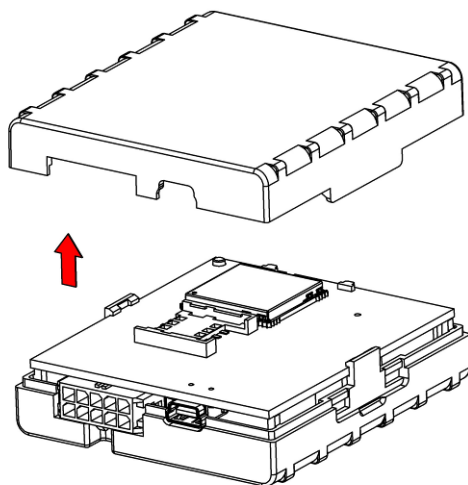

②

Remove FMA110 case

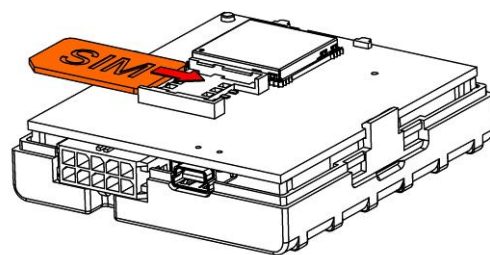

③

Insert SIM card as shown

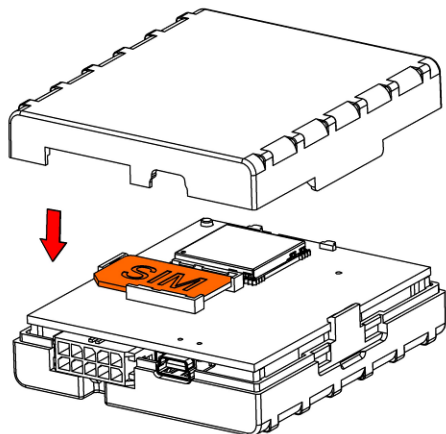

④

Attach top housing cover

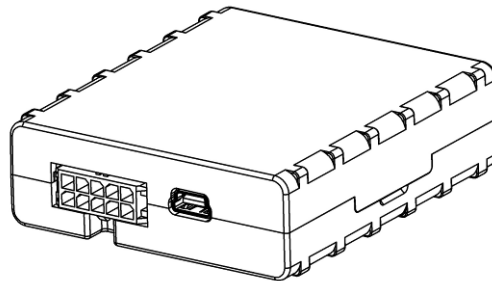

⑤

Device is ready

3.2 Installing FMA110 drivers

3.2.1 System requirements for FMxxxx configurator

Software requirements	
Operating system	32-bit and 64-bit: Windows XP with SP3 or later, Windows Vista, Windows 7, Windows 8/8.1, Windows 10
Microsoft .NET framework	v4.0 (https://www.microsoft.com/)
Hardware requirements	
RAM	100 MB of available memory
Display	1024 x 768 or higher resolution monitor
Additional requirements	In configurators where map for geofence zone configuration is available internet connection is required

3.2.2 Drivers

Please download Virtual COM Port drivers from Teltonika website:
http://av11.teltonika.lt/downloads/FM11YX/vcpdriver_v1.3.1_setup.zip

3.2.3 Installing drivers

Extract and run VCPDriver_V1.3.1_Setup.exe. This driver is used to detect FMA110 device connected to the computer. Click 'Next' in driver installation window (figures below):

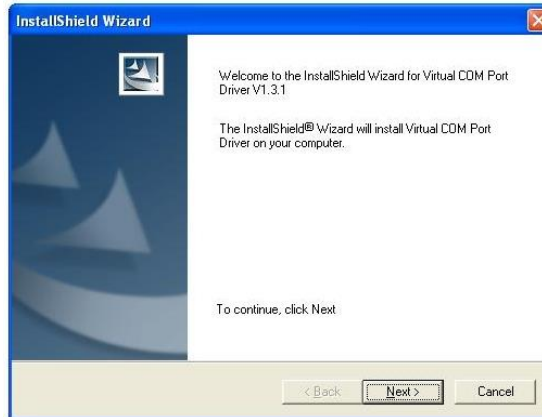

Figure 2 Driver installation window

This will launch device driver installation wizard. In the following window click 'Next' button again:



Figure 3 Driver installation window

Setup will continue installing drivers and will display a window about successful process at the end. Click 'Finish' to complete setup:



Figure 4 Driver installation window

You have now installed drivers for FMA110 device successfully.

3.3 Navigate LED

Behaviour	Meaning
Permanently switched on	GPS signal is not received
Blinking every second	Normal mode, GPS is working
Off	GPS is turned off because: <ul style="list-style-type: none"> • Deep sleep mode Or <ul style="list-style-type: none"> • GPS module is turned off

3.4 Status LED

Behaviour	Meaning
Blinking every second	Normal mode
Blinking every 2 seconds	Deep sleep mode
Blinking fast for a short time	Modem activity
Blinking fast constantly	Boot mode
Off	<ul style="list-style-type: none"> • Device is not working Or <ul style="list-style-type: none"> • Device firmware being flashed

3.5 Socket 2x5

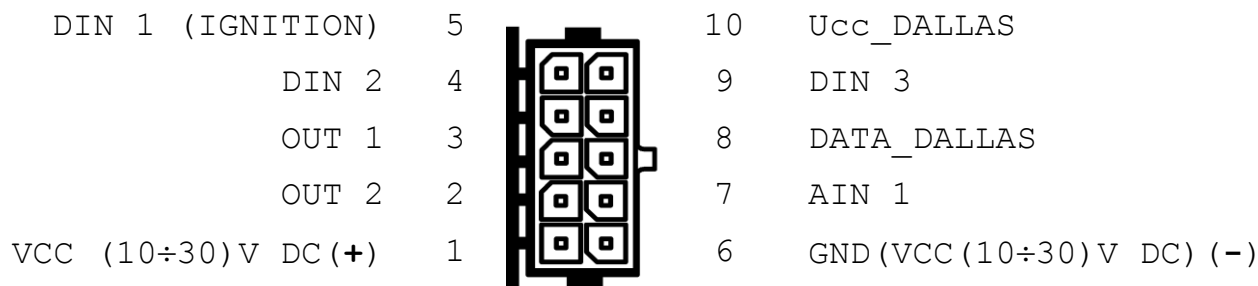

Figure 5 2x5 socket pinout

Pin Nr.	Pin Name	Description
1	VCC (10÷30)V DC (+)	Power supply for module. Power supply range (10...30) V DC
2	OUT 2	Digital output. Channel 2. Open collector output. Max. \overline{I} 300mA.
3	OUT 1	Digital output. Channel 1. Open collector output. Max. \overline{I} 300mA.
4	DIN 2	Digital input, channel 2
5	DIN 1	Digital input, channel 1 DEDICATED FOR IGNITION INPUT
6	GND(VCC(10÷30)V DC)(-)	Ground pin. (10÷30)V DC (-)
7	AIN 1	Analog input, channel 1. Input range: 0-30V/0-10V DC
8	DATA_DALLAS	Data channel for Dallas 1-Wire® devices
9	DIN 3	Digital input, channel 3
10	Ucc_DALLAS	+ 3,8 V output for Dallas 1-Wire® devices. (max 20mA)

Table 2. Socket 2x5 pinout description

3.6 USB

Mini USB connector

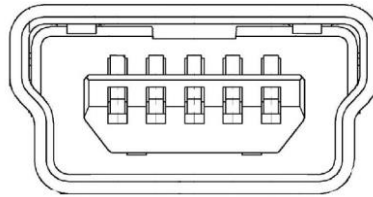

Figure 6 Mini USB type B connector

FMA110 connected to PC creates an STM Virtual COM Port, which can be used as a system port (to flash firmware and configure the device):

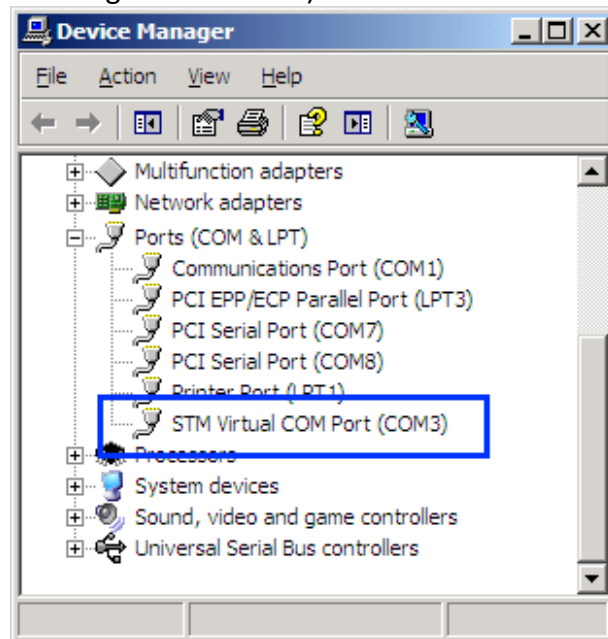

Figure 7 COM-Ports

3.7 Accessories



Note: Teltonika does not provide any additional equipment like panic buttons, door sensors or others.

1 – Wire devices

One of the realized features FMA110 is 1-Wire[®] data protocol, which enables connection of thermometer (DS1820, DS18S20 and DS18B20) and I-Button type: DS1990A (Figures 8 and 9 show FMA110 and 1-wire[®] device connection schemes).

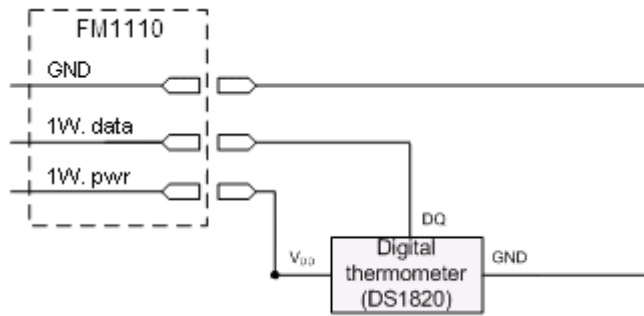

Left row of pins

1W. PWR (FMA110 – pin10)	1
1W. Data (FMA110 – pin8)	2
GND (FMA110 – pin6)	3
Digital Input	4

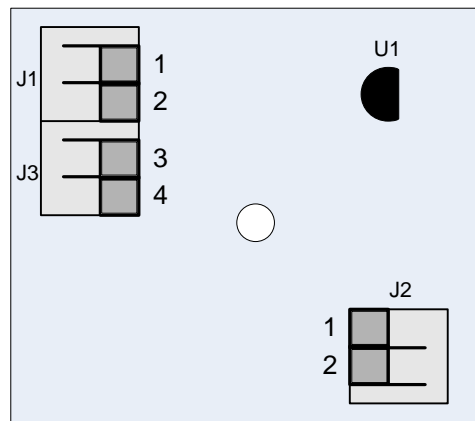

Right row of pins

1	Vpp (+5 Volts DC) – power source for external digital sensor
2	Output from external digital sensor

Figure 8 Digital thermometer DS1820 and TTJ100 connection scheme

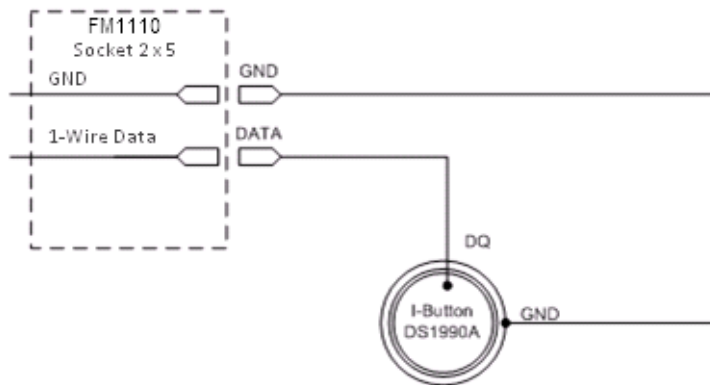
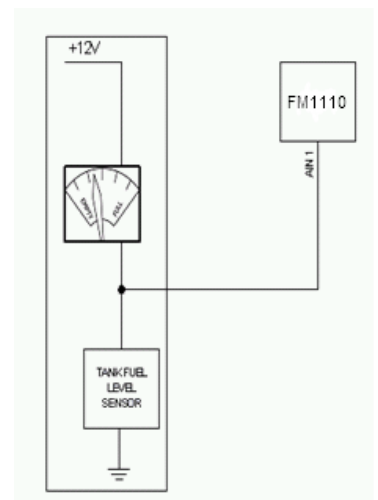

Figure 9 I-Button DS1990A connection scheme

Fuel Tank sensors

A fuel tank level sensor exists in most cars, which shows the approximate fuel level in the driver's indicator panel. It is possible to connect FMA110 Analog input to it (if sensor returns analogue signal proportional to fuel level). Figure 10 shows the connection scheme to the FMA110 and fuel tank sensor. After the connection to the tank fuel level sensor, calibration is needed. Calibration is needed because most fuel tank sensors are not linear. Calibration is performed by measuring voltage dependence on volume of fuel in tank.



Alarm buttons, door sensors, etc.

Alarm buttons, door sensors, ignition, etc. return two states: high or low voltage. Digital inputs are used to read this information. Figure below shows how to connect alarm button, door sensor, etc.

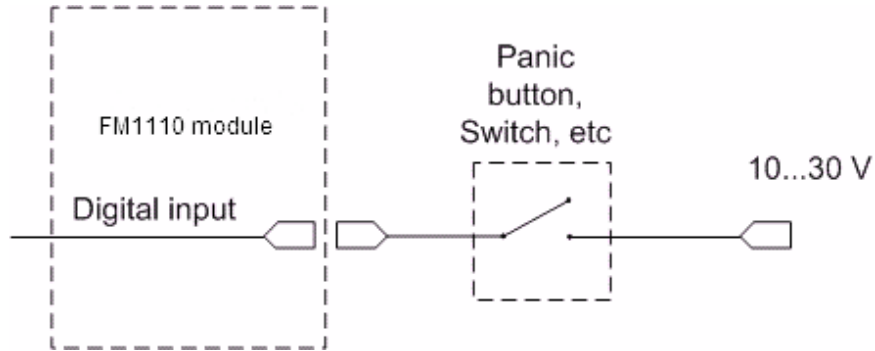

Figure 11 Panic button connection

In cases when sensor output signal is negative, an additional relay has to be installed to convert negative signal to positive.

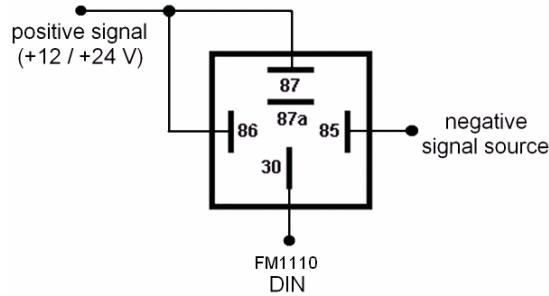

Figure 12 Inverting relay connection

Immobilizer relay

When connected as shown below, FMA110 disables engine starter when output is ON. More details about relays can be found below.

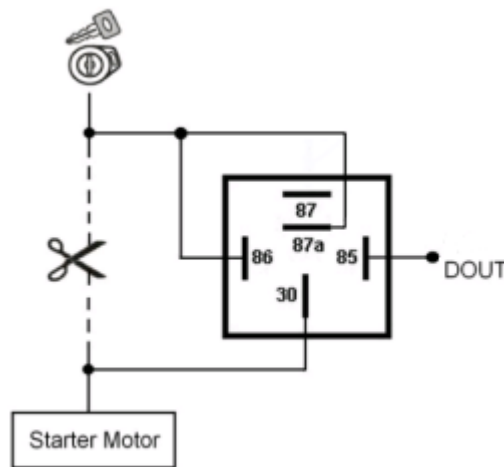

Figure 13 Immobilizer relay connection

Relays

An ordinary automotive relay is used to invert input signal or to immobilize engine starter. Note, that they are available as 12 V or 24 V.

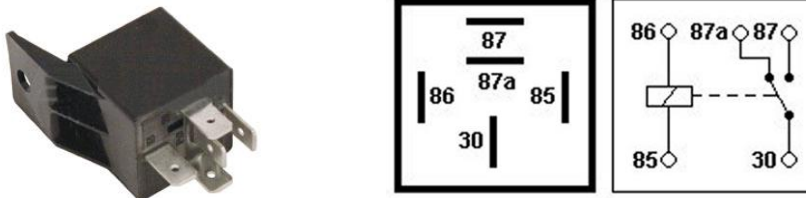

Figure 14 Automotive relay pinout

4 FIRMWARE

4.1 Updating firmware using USB cable

FMA110 functionality is always improving, new firmware versions are developed. Current module firmware version can be retrieved from Configurator.

Connect FMA110 to PC with the USB cable. Launch "Firmware Updater", select COM port to which device is connected, click connect, and when IMEI and Firmware version fields are filled, start the update. Device needs some time to send IMEI and Firmware version, so do not be afraid if IMEI will not show up immediately, disconnect and after 1-2 minutes try to connect again. When starting update device will open link with updater. With link open device downloads firmware and starts installing. Wait thru all these screens as in **Figure 16** for firmware to update. Update process may take up to several minutes.

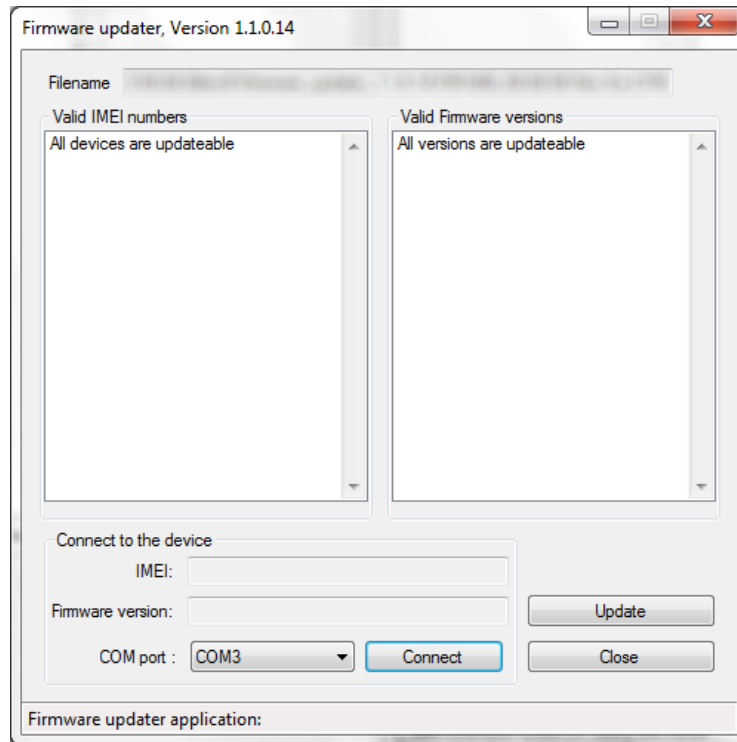

Figure 15 FMA110 firmware updater screen

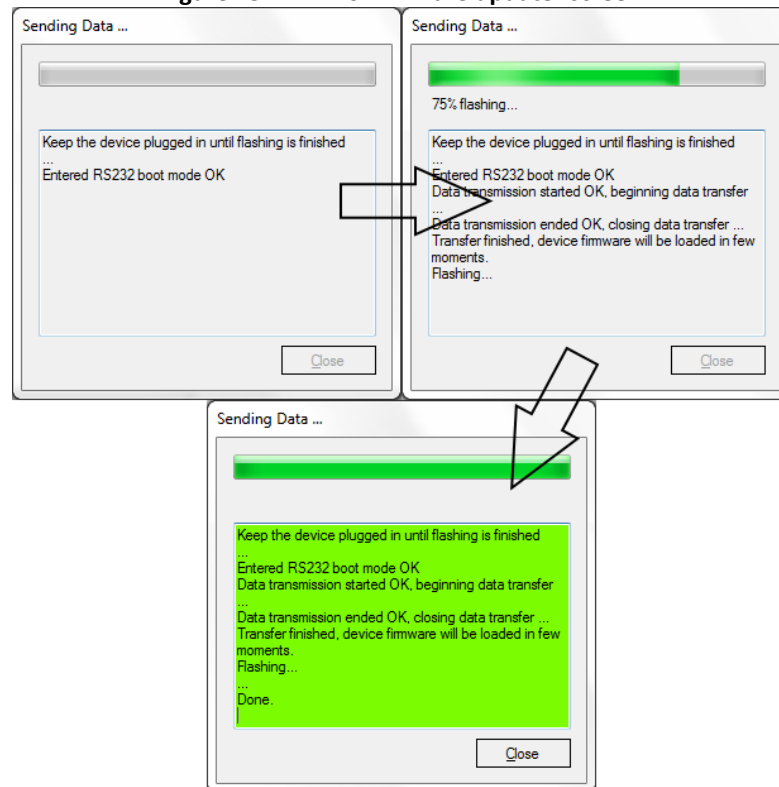

Figure 16 Firmware updating processes

When you see a green table like in **Figure 16**, it means that the firmware is flashed to FMA110 successfully. You may now close the update window and start using your FMA110 device.

5 OPERATIONAL BASICS

5.1 Operational principals

FMA110 module is designed to acquire records and send them to the server. Records contain GPS data and I/O information. Module uses GPS receiver to acquire GPS data and is powered with four data acquire methods: time-based, distance-based, angle-based and speed-based method. Note, that if FMA110 loses connection to GPS satellites, it continues to make records, however coordinate in these records remains the same (last known coordinate). Method's details are described in section 5.13. All data is stored in flash memory and later can be sent via GPRS or SMS. GPRS mode is the most preferred data sending mode. SMS mode is mostly used in areas without GPRS coverage or GPRS usage is too expensive.

GPRS and SMS settings are described in later sections. FMA110 communicates with server using special data protocol. Data protocol is described in device protocols documentation.

FMA110 can be managed by SMS commands. SMS Command list is described in SMS COMMAND LIST section. Module configuration can be performed over TCP or via SMS. Configuration parameters and modes are described in device protocols documentation. Please contact Teltonika sale manager to find out more about protocols documentation purchase.

5.2 Sleep modes

5.2.1 Sleep mode

FMA110 is able to go to sleep mode after configurable Sleep timeout. This timeout (defined period) starts counting when device is in STOP mode. After timeout is reached and all conditions for sleep mode are met, device goes to sleep mode. While in sleep mode, FMA110 turns GPS module off and it is not making new periodic records. Only event records is being recorded with last known coordinate and sent to AVL server. As a result power usage decreases allowing saving vehicle battery.

FMA110 can enter sleep mode if **ALL** of these conditions are met:

- FMA110 has to be configured to work in Sleep mode and Sleep timeout is reached;
- Device must be synchronized time with GPS satellites;
- No movement by movement sensor is detected;
- Ignition (configured Ignition Source) is off;
- USB cable detached;

FMA110 exits sleep mode when if **ONE** of following conditions are true:

- Movement by movement sensor is detected;
- Ignition (configured Ignition Source) is turned on;
- USB cable is connected;

5.2.2 Deep Sleep mode

While in deep sleep mode, FMA110 sets GPS receiver to sleep mode and turns off GSM/GPRS module (it is not possible to wake up device via SMS). Despite records with last known coordinate are being saved and send to AVL server (GSM/GPRS module is turned on to send data and after that it is turned off again), power usage is decreased to save vehicle's battery. Note, that power saving depends on two configurable parameters: send period and min. record saving period.

FMA110 can enter deep sleep mode if **ALL** of these conditions are met:

- FMA110 has to be configured to work in Deep Sleep mode and Sleep timeout set;
- Device must be synchronized time with GPS satellites;
- No movement by movement sensor is detected;
- Ignition (configured Ignition Source) is off;
- USB cable detached;
- “Min. Record Saving Period” (Data Acquisition Mode settings) must be bigger value than “Sleep timeout” plus “Active Data Link Timeout” parameter.
- “Send period” (Data Acquisition Mode settings) must be bigger value than “Sleep timeout” plus “Active Data Link Timeout” parameter.

FMA110 exits deep sleep mode when if **ONE** of following conditions are true:

- Movement by movement sensor is detected;
- Ignition (configured Ignition Source) is turned on;
- USB cable is connected;



Note: In order to save GPRS traffic records saved in deep sleep mode do not contain below listed I/O elements information:

PDOP, HDOP, Odometer, Speedometer, iButton ID, Cell ID, Area Code, Temperature and GPS power

5.3 Virtual odometer

Virtual odometer is used to calculate traveled distance in FMA110 as a separate I/O element. When FMA110 detects movement, it starts counting distance using GPS signal: every second it checks current location and calculates distance between current and previous point. It keeps adding these intervals until it is time to make a record, then FMA110 records its location and adds odometer value, which is equal to the sum of all distances, measured every second. When record is made, odometer resets to zero and distance calculation starts all over again.

Virtual odometer (total distance) as an I/O element can be also used with Trip feature, read chapters 5.4.2 and 5.14.2 for more details.

5.4 Features

Using available features can greatly increase FMA110 usability options.

5.4.1 Scenarios

Four scenarios are available on FMA110 device.

Green driving, Overspeeding, Jamming detection and Immobilizer scenarios can be used to manage digital output 1 and digital output 2. A single digital output can be controlled by a few scenarios. However, **it is not recommended to configure Immobilizer and other scenarios on the same digital output.**

Green Driving Scenario. Helps to inspect driver and prevent about harsh driving. Scenario continuously monitors: accelerating force, braking force and cornering angles and warns driver if needed. The scenario can control DOUT to alert the driver, with, for example, a buzzer or an LED.

To save GPRS traffic Green Driving **event** will be **generated (included into sent records) only** when FMA110 measured values are higher than those set in configuration, without additional I/O settings.

To prevent generating false events, harsh acceleration and harsh braking is monitored only when following conditions are fulfilled:

- Ignition is ON (configured Ignition Source = 1)
- Vehicle speed is equal or higher than 10km/h

Harsh cornering is monitored only when following conditions are fulfilled:

- Ignition is ON (configured Ignition Source = 1)
- Vehicle speed is equal or higher than 30km/h



Note: Green Driving Scenario is a factor on various cars and various drivers testing phase and can be subject to changes. Teltonika is constantly working on improvement of the functionality of the devices, and strongly recommends using the latest version of the firmware.

Over Speeding Scenario. Helps to inspect the driver and prevent exceeding the fixed speed limit. The scenario can control DOUT to alert the driver, with, for example, a buzzer or an LED.

Jamming scenario. Radio jamming is the (usually deliberate) transmission of radio signals that disrupt communications by decreasing the signal to noise ratio. When jamming detection is enabled, FMA110 informs (with buzzer or LED, connected to DOUT) driver about jamming event. Jamming can be deactivated with iButton.

Immobilizer Scenario. Vehicle can be used only if an iButton is connected and it passes the security check. The scenario can control DOUT to alert the driver, with, for example, a buzzer or LED. *iButton list checking* parameter lets the user use this scenario for authorization. The parameter allows up to 50 unique iButton owners (specified in the iButton list) to be authorized to use the vehicle.



Note: In order for Immobilizer scenario with enabled *iButton list checking* to work properly, at least 1 iButton ID must be written to the iButton list.

5.4.2 Trip

Trip customizable feature enables user extended monitoring of performed trips (from engine start at present location to engine stop at arrived location), log their start and stop points, view driven trip distance¹. Event will be **generated (included into send records) only** when trip starts and finishes.

¹ Continuous Trip distance is counted only for ONE trip. If trip is finished (stop point is detected), trip distance resets to 0 (zero). Next trip will start counting from the beginning.



Note: Scenarios and Trip features are activated (DOUTs are activated) only if configured Ignition Source=1 (ignition is on).

5.4.3 Geofencing

Geofencing is another feature which is highly customizable and can detect wherever car enters or leaves customized areas. More about Geofencing can be read in 5.14.3 chapter.

Auto Geofencing feature if enabled is activated automatically by turning off car ignition (configured Ignition Source). Next time before driving user has to disable Auto Geofencing with iButton or by turning on car ignition. In case of theft car leaves Auto Geofencing zone without authorization FMA110 device automatically sends high priority record to AVL application.

5.4.4 iButton list

iButton list is used to enter authorized iButton ID codes, which are used to authenticate driver in Immobilizer scenario, Auto Geofencing options and DOUT deactivation in Jamming scenario.

5.5 CONFIGURATION

5.6 Configurator

New FMA110 module has default factory settings. Settings should be changed according to your application and your GSM operator information.

FMA110 configuration is performed via FMA110 Configurator program. FMA110 Configurator version can be downloaded from <http://avl1.teltonika.lt/downloads/FM11YX/>. Contact sales manager to get the latest FMA110 Configurator version. FMA110 configurator operates on Microsoft Windows OS and uses MS .Net Framework 3.5 or higher. Please ensure that MS .Net Framework 3.5 or later is installed on your PC before starting configurator. Latest MS .Net Framework version can be downloaded from official Microsoft web page.

Module configuration is performed over USB cable. Configuration process starts from starting FMA110 Configurator program and then connecting to FMA110 device via Connect button located on the top left corner of configurator. If connected successfully IMEI, Version fields which were empty, now are filled with certain numbers depending on Modem IMEI and firmware version of your device (figure below).

FMA110 has one user editable profile, which can be loaded from device, and saved. User can also revert to default settings, by pressing Load Defaults button. After any modification of configuration settings it has to be saved to FMA110 device, otherwise it will not be written to device.

FMA110 has 2 configuration modes: Recommended Configuration (Figure 17) and Advanced Configuration (Figure 18).

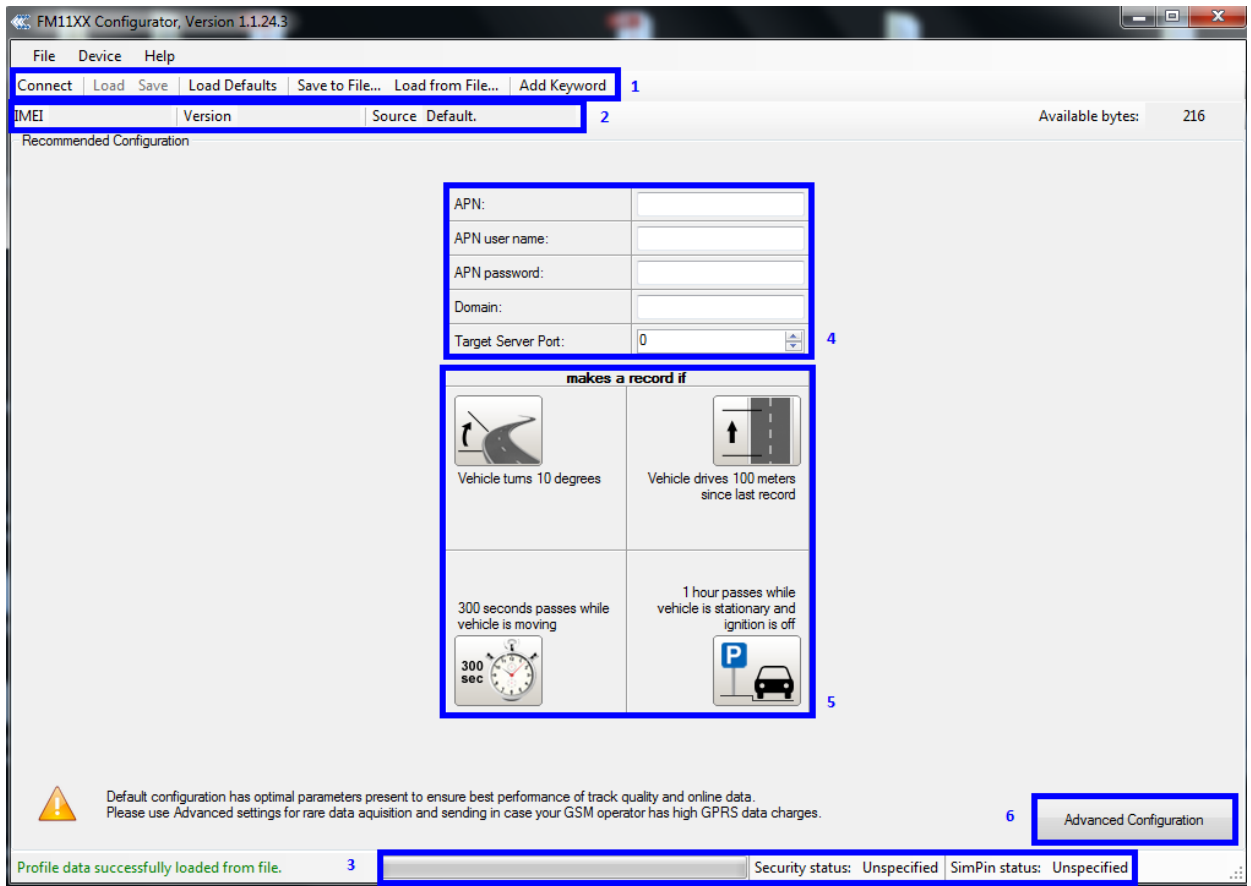

Figure 17 Recommended Configuration window

Recommended Configuration mode uses predefined data acquisition values. In this configuration mode it is only required to enter network parameters. In Advanced Configuration mode FMA110 is more configurable.

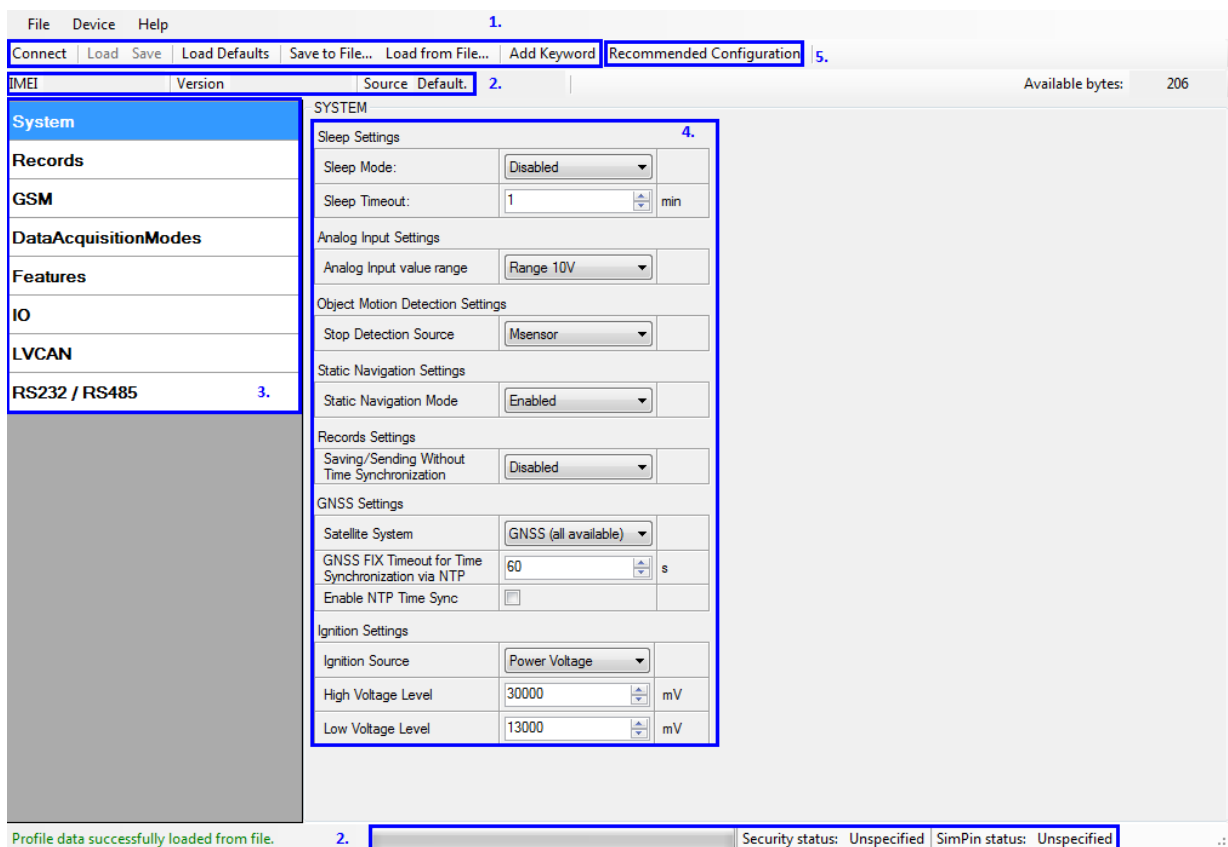

Figure 18 Advanced Configuration window

FMA110 Configurator is divided into main areas: 1 – main button area, 2 – information area, 3 – settings menu, 4 – parameters and values menu, 5 – recommended configuration values.

Button 5 is used to change between configuration modes.

Main Buttons description:

‘Connect’ – connects device

‘Load’ – reads configuration parameters from FMA110 Flash memory.

‘Save’ – saves configuration parameters to FMA110 Flash memory.

‘Load Defaults’ – loads default FMA110 settings that later can be modified. This procedure must be performed before entering new parameters.

‘Save to File...’ – allows user to save currently entered settings to .XML file, for later usage.

‘Load from File...’ – allows user to load configuration saved in .XML extension file.

‘Reset device’ – reboots FMA110 and displays processor firmware version.

Additional Buttons description:

‘SIM PIN’ - allows to enter PIN code if inserted SIM card has activated PIN code security. Note that PIN code can be entered 2 times.

‘Add Keyword’ / ‘Change Keyword’ / ‘Switch Security Off’ – buttons are used to protect configurator from unauthorized access to configuration.

Keyword is 4 – 10 symbol length. If keyword is set, every time user reconnects FMA110 to USB port, user will be asked to provide valid keyword when connecting FMA110 to configurator. User is given 5 attempts to enter keyword. After entering valid keyword, counter resets to 5.

If user disconnects FMA110 using 'Disconnect' button and does not disconnect from USB port, after reconnecting using 'Connect' button, configurator does not ask for keyword.



ATTENTION! If you have entered a keyword, disconnected from the configurator and then later connected again, you will need to enter the keyword that you have entered previously. If you have forgotten it, please contact your local sales manager.

5.7 Record storage

FMA110 can store up to 3500 data records if GSM or GPRS is not available at the moment. It will send data later when GPRS is available again. Note that FMA110 can have memory full of records. In such case it will start deleting oldest records in order to save new ones. Sending all the data records to server may take some time. Sending 3500 records for FMA110 may take for about 2 hours (exact time may differ depending on GPRS/server load).

You can access all uploaded data from TAVL4 application.

More details on how to use TAVL application please refer to "TAVL4 application user manual" documentation.

5.8 System settings

System settings have 7 configurable parameters:

- Deep sleep settings, where user can turn deep sleep on or off;
- Analog Input Settings, where user can choose analog input range 10 V or 30 V, depending on needed accuracy (lower range gives higher accuracy of measurements), and input voltage;
- Object Motion Detection Settings, where user can configure 3 ways how FMA110 will detect stopped movement, and change its working mode (for working modes, read section 5.13);
- Static navigation settings, where user can turn static navigation on or off;
- Records Settings, where user can enable or disable records when GPS is not available (no time synchronization);
- GNSS Settings, where user can choose satellite system and time synchronization via NTP (Network Time Protocol)
- GNSS Settings, where user can choose satellite system;
- Ignition Source sets ignition triggered functionalities to be triggered by:
 - Power Voltage (if voltage is between High Voltage Level and Low Voltage Level the ignition is considered to be turned on);
 - Digital Input (DIN1 ON – ignition on, DIN1 OFF – ignition off);
 - Movement (if accelerometer/movement sensor detects movement then ignition is on, if movement stops – ignition is off).

Stop Detection Source	Vehicle on Stop mode	Vehicle Moving mode
Ignition (recommended)	If ignition (configured Ignition Source) is logic low	If ignition (configured Ignition Source) is logic high

Msensor (movement sensor)	Internal movement sensor does not detect movement	Internal movement sensor detects movement
GPS	GPS fix is available and vehicle speed is lower than 5 km/h	GPS fix is available and vehicle speed is higher than 5 km/h
	While GPS fix is unavailable, Object Motion Detection Settings are working like in Msensor mode	

Static Navigation Mode is a filter, which filters out track jumps when the object is stationary. If Static navigation filter is disabled, it will apply no changes on GPS data. If Static navigation filter is enabled, it will filter changes in GPS position if no movement is detected (depends on Object Motion Detection Settings). It allows filtering GPS jumps when object is parked (is not moving) and GPS position is still traced.

System	SYSTEM	
Records	Sleep Settings	
GSM	Sleep Mode:	Disabled
DataAcquisitionModes	Sleep Timeout:	1 min
Features	Analog Input Settings	
IO	Analog Input value range	Range 10V
LVCAN	Object Motion Detection Settings	
RS232 / RS485	Stop Detection Source	Msensor
	Static Navigation Settings	
	Static Navigation Mode	Enabled
	Records Settings	
	Records saving/sending	After position fix
	GNSS Settings	
	Satellite System	GNSS (all available)
	GNSS FIX Timeout for Time Synchronization via NTP	60 s
	Enable NTP Time Sync	<input type="checkbox"/>
	Ignition Settings	
	Ignition Source	Power Voltage
	High Voltage Level	30000 mV
	Low Voltage Level	13000 mV

Figure 19 System settings configuration

5.9 Records settings

Here user can modify if FMA110 device will send newest records first, meaning, that the most important thing is to know recent position of car, older records are being sent right after newest records arrive to AVL application.

Activate Data Link Timeout is used to set timeout of link between FMA110 and AVL application termination. If FMA110 has already sent all records it waits for new records before closing link. If new records are generated in the period of this timeout, and minimum count to send is reached, they are sent to AVL application. This option is useful when GSM operator charge for link activation.

Server Response Timeout is used to set time period waiting for response from server side.

RECORDS		
Record Settings		
Sorting	From newest	
Active Data Link Timeout	60	sec.
Server Response Timeout:	300	sec.

Figure 20 Records settings configuration

5.10 GSM settings, GPRS part

'GPRS' defines main parameters for FMA110: GSM operator APN and GPRS username and password (optional – depending on operator), destination server IP and port, and allows to set protocol used for data transfers – TCP or UDP

Some operators use specific authentication for GPRS session – CHAP or PAP. If any of these is used, APN should be entered as 'chap:<APN>' or 'pap:<APN>'. I.e. if operator is using APN 'internet' with CHAP authentication, it should be entered as 'chap:internet'. Information about APN and authentication type should be provided by your GSM operator.

GPRS data sending Settings	
GPRS Context Activation	Enabled
Protocol	TCP
Always Online	Disabled
APN:	GSM provider APN
APN user name:	
APN password:	
Domain:	127.0.0.1
Target Server Port:	65535

Figure 21 GPRS configuration

Always online mode – never close link to server if enabled, even in deep sleep.

5.11 GSM settings, SMS part

Essential fields in 'SMS' part are 'Login' and 'Password'. The login and password are used with every SMS sent to FMA110. If login and password are not set, in every SMS sent to FMA110 device two spaces before command have to be used (<space><space><command>).

Command structure with set login and password:

<login><space><password><space><command>, example: "asd 123 getgps"

Phone numbers have to be written in international standard, without using "+" or "00" signs in prefix. If no numbers are entered, configuration and sending commands over SMS are allowed from all GSM numbers.

SMS data sending settings – enable or disable **periodic** data and event SMS usage. This setting does not affect replies to SMS request messages – answers are always sent back to sender telephone number.

FMA110 can send binary SMS with 24-coordinates-in-one-SMS. It is used in areas where no GPRS coverage is available. Module collects data and sends to server binary SMS containing information about last 24 collected points. SMS sending schedule is set in SMS Week Time tab. 24-Coordinates SMS decoding is described in device protocols documentation. Please contact Teltonika sale manager to find out more about protocols documentation purchase.

<p>System</p> <hr/> <p>Records</p> <hr/> <p>GSM</p> <p>> GPRS</p> <p>> SMS</p> <p>> SMS Events</p> <p>> Operator list</p> <p>DataAcquisitionModes</p> <hr/> <p>Features</p> <hr/> <p>IO</p> <hr/> <p>LVCAN</p> <hr/> <p>RS232 / RS485</p>	<p>SMS data sending Settings</p> <p>SMS data sending Settings: Enabled</p> <p>SMS login: <input type="text" value="asd"/></p> <p>SMS password: <input type="password" value="***"/></p> <p>Authorized phone numbers:</p> <table border="1"> <thead> <tr> <th></th> <th>Phone Number</th> </tr> </thead> <tbody> <tr> <td>▶ 01*</td> <td>37061234567</td> </tr> <tr> <td>02</td> <td></td> </tr> <tr> <td>03</td> <td></td> </tr> <tr> <td>04</td> <td></td> </tr> <tr> <td>05</td> <td></td> </tr> <tr> <td>06</td> <td></td> </tr> <tr> <td>07</td> <td></td> </tr> <tr> <td>08</td> <td></td> </tr> <tr> <td>09</td> <td></td> </tr> <tr> <td>10</td> <td></td> </tr> </tbody> </table> <p>(*Server Phone Number)</p>		Phone Number	▶ 01*	37061234567	02		03		04		05		06		07		08		09		10	
	Phone Number																						
▶ 01*	37061234567																						
02																							
03																							
04																							
05																							
06																							
07																							
08																							
09																							
10																							

Figure 22 SMS configuration



Note: A mobile phone will not understand SMS with binary code, so sending it to a mobile phone is useless. When sending a binary SMS to a phone number, which is a server phone number, the server can interpret and understand binary code, so the data can be read and you can view it on the server.



SMS login and password and authorized number list are used to protect FMA110 module from unauthorized access. Module accepts messages only from a list of authorized numbers and with proper module login and password. Numbers must be without “+” or “00” prefix. If no authorized numbers are entered, module accepts messages from all numbers.

5.12 GSM settings, Operator list

Operators list – FMA110 can work in different modes (use different settings) according to the operator list defined. Operator list is used for Data Acquisition Mode switching (see chapter 5.13 Data Acquisition Mode settings for more details). Modes are changed based on GSM operator FMA110 is connected to.

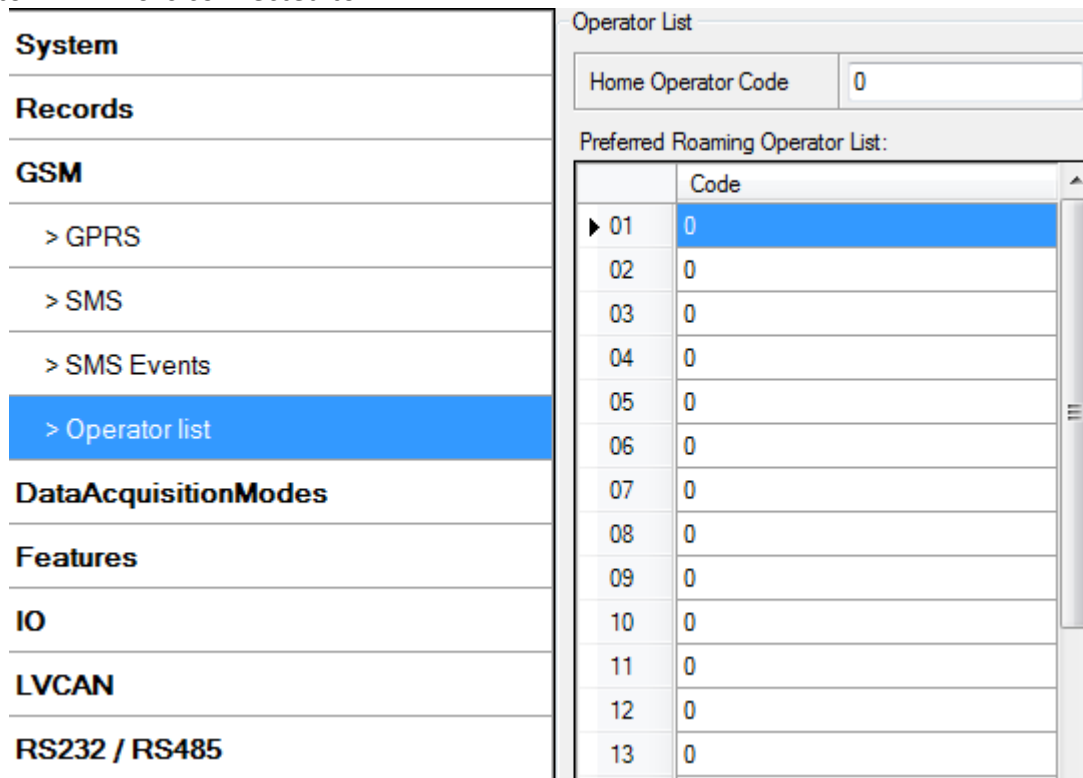

Figure 23 Operator list configuration

If operator list is left empty, it will allow using GPRS to any GSM operator. Please note that FMA110 will work in **Unknown mode only** (make sure it is configured to allow data sending – GPRS context is enabled).

Operator Blacklist. Operator BlackList Functionality algorithm: Device tries to connect to an operator with the strongest signal. It will prioritize operators which are specified in the operator list. If no operators from the operator list are available, the device will try to connect to an operator from the blacklist. If the device connects to an operator from the blacklist, it will not be allowed to connect to the internet or send SMS messages. If no suitable operator is found on both lists, the device will try to connect to a remaining available operator with the strongest signal. The brief functionality is shown in diagram below:

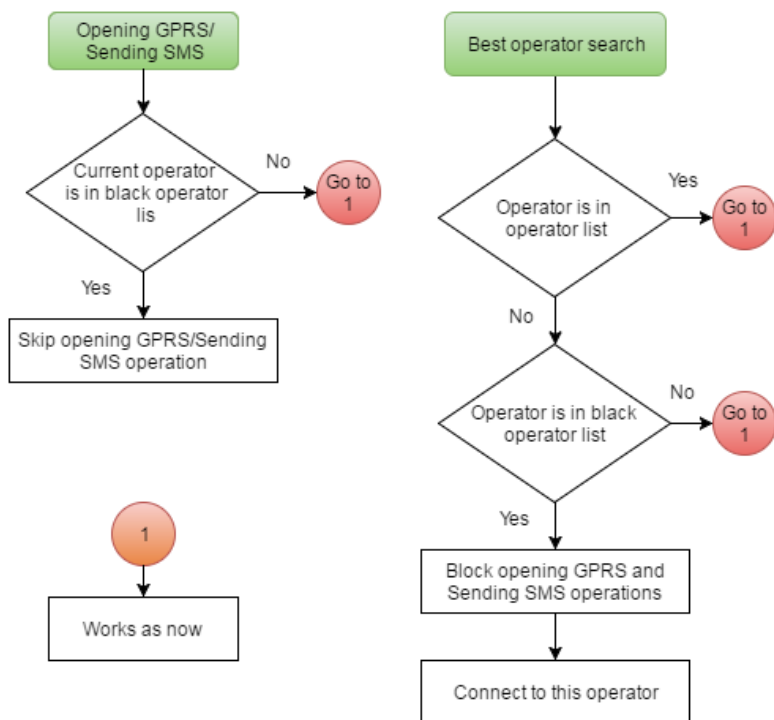

Figure 24 Black operator list functionality

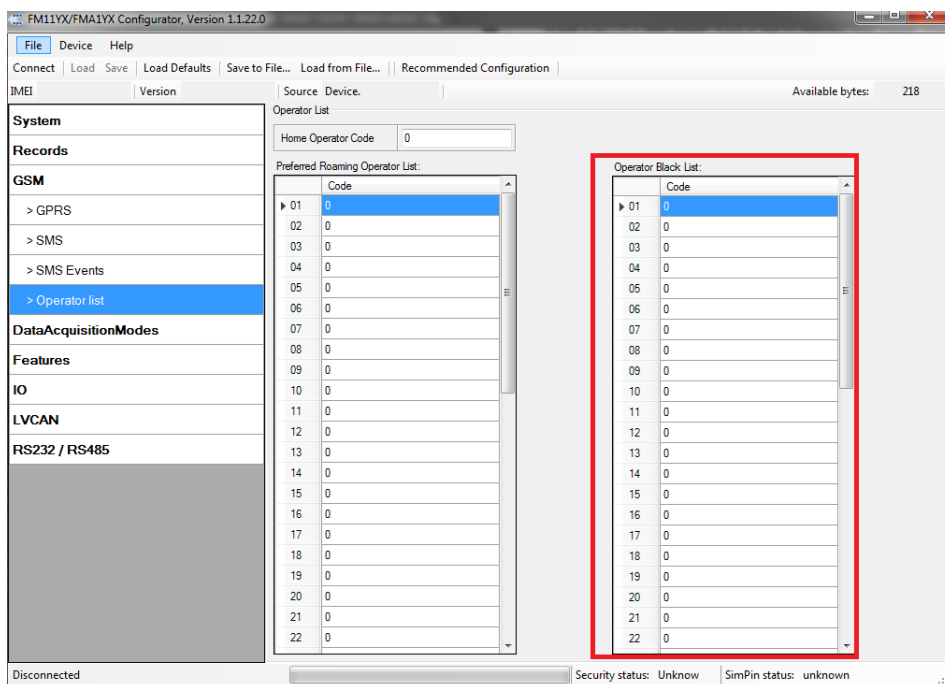

Figure 25 Black operator list configuration

5.13 Data Acquisition Mode settings

Data Acquisition Modes are an essential part of FMA110 device, it is also highly configurable.

By configuration user defines how records will be saved and sent. There are three different modes: Home, Roaming and Unknown. All these modes with configured data acquisition and send frequencies depend on current GSM Operator defined in Operator list (see section 5.12) and are switched when GSM operator changes (e.g. vehicle passes through country boarder).

If current GSM operator is defined as Home Operator, device will work in Home Data Acquisition mode, if current operator is defined as Roaming Operator, device will work in Roaming Data Acquisition mode, and if current operator code is not written in Operator list (but there is at least one operator code in the operator list), device will work in Unknown Acquisition mode.

This functionality allows having different AVL records acquire and send parameters values when object is moving or stands still. Vehicle moving or stop state is defined by Stop Detection Source parameter. There are 3 ways for FMA110 to switch between Vehicle on Stop and Vehicle Moving modes see section 5.7.

FMA110 allows having 6 different modes. Operational logic is shown in Figure 24.



If there are no operator codes entered into operator list, FMA110 will work in Unknown network mode ONLY.

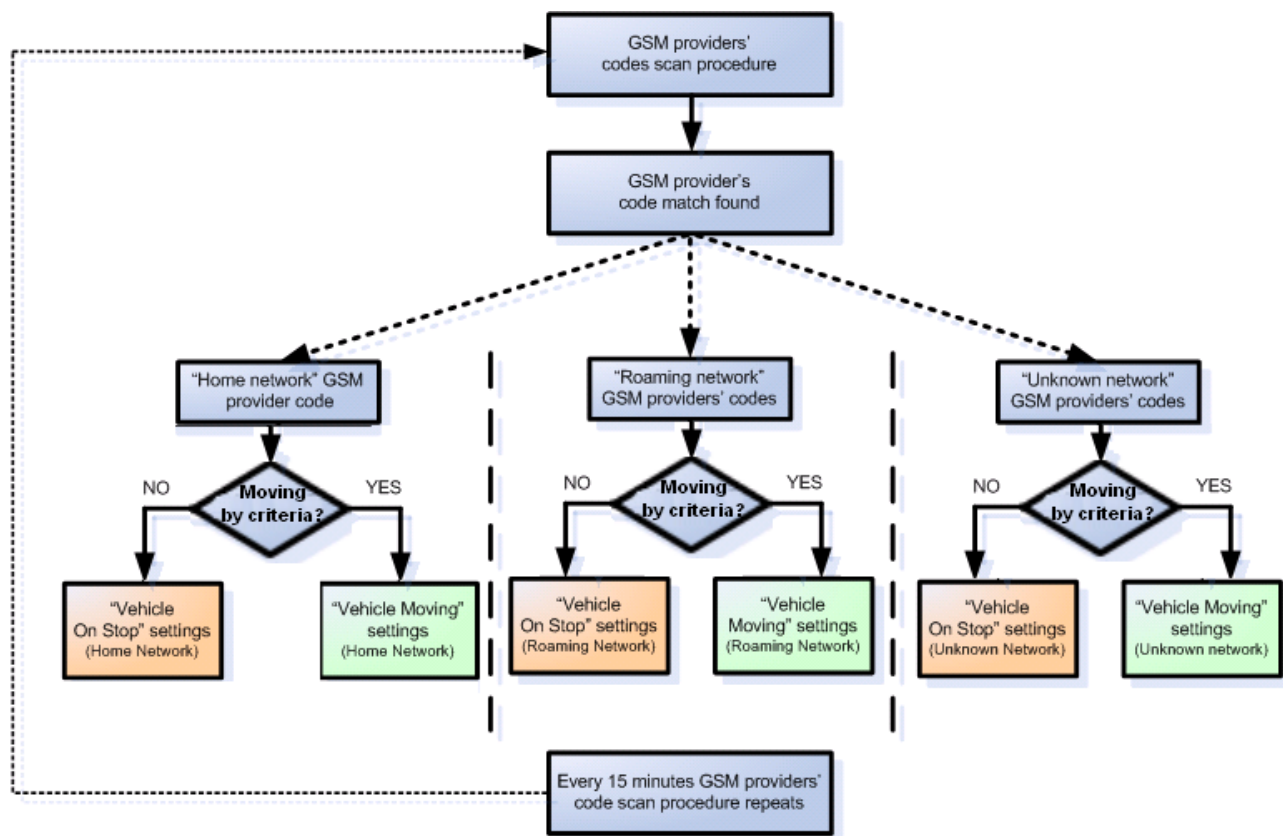

Figure 26 Data Acquisition Mode configuration

Operator search is performed every 15 minutes. Depending on current GSM operator, Home, Roaming or Unknown mode can be changed faster than every 15 minutes. This process is separate from operator search. Movement criteria are checked every second.

Data Acquisition Modes : Home

Vehicle on STOP			Vehicle MOVING		
Min Period:	600	sec.	Min Period:	30	sec.
			Min Distance:	200	m.
			Min Angle:	20	deg.
Min Saved Records:	1		Min Speed Delta:	0	km/h
Send Period:	1	sec.	Min Speed Source:	GPS	
			Min Saved Records:	1	
			Send Period:	1	sec.

GPRS Week Time

Data Acquisition Modes : Roaming

Vehicle on STOP			Vehicle MOVING		
Min Period:	600	sec.	Min Period:	1200	sec.
			Min Distance:	1000	m.
			Min Angle:	30	deg.
Min Saved Records:	10		Min Speed Delta:	0	km/h
Send Period:	600	sec.	Min Speed Source:	GPS	
			Min Saved Records:	10	
			Send Period:	600	sec.

GPRS Week Time

Data Acquisition Modes : Unknown

Vehicle on STOP			Vehicle MOVING		
Min Period:	3600	sec.	Min Period:	300	sec.
			Min Distance:	100	m.
			Min Angle:	10	deg.
Min Saved Records:	1		Min Speed Delta:	0	km/h
Send Period:	1	sec.	Min Speed Source:	GPS	
			Min Saved Records:	1	
			Send Period:	1	sec.

GPRS Week Time

Figure 27 Data Acquisition Mode configuration

'Min Saved Records' defines minimum number of coordinates and I/O data that should be transferred with one connection to server. If FMA110 does not have enough coordinates to send to server, it will check again after time interval defined in 'Sending Period'

Send period – GPRS data sending to server period. Module makes attempts to send collected data to server every defined period. If it does not have enough records (depends on parameter Min. Saved Records described above), it tries again after defined time interval.

GPRS Week Time tab – most GSM billing systems charge number of bytes (kilobytes) transmitted per session. During the session, FMA110 makes connection and transmits data to a server. FMA110 tries to handle the session as much as possible; it never closes session by itself. Session can last for hours, days, weeks or session can be closed after every connection in certain GSM networks – this depends on GSM network provider. GPRS Context Week Time defines session re-establish schedule if session was closed by network. New GPRS context is opened if time is 10 minutes till time checked in table. Therefore if all boxes are checked, FMA110 is able to open new connection anytime. At scheduled time match FMA110 checks for GPRS session activity. If GPRS session is alive, FMA110 sends data to server according to Send period parameter. If it is not, FMA110 checks if it is able to re-establish the session.

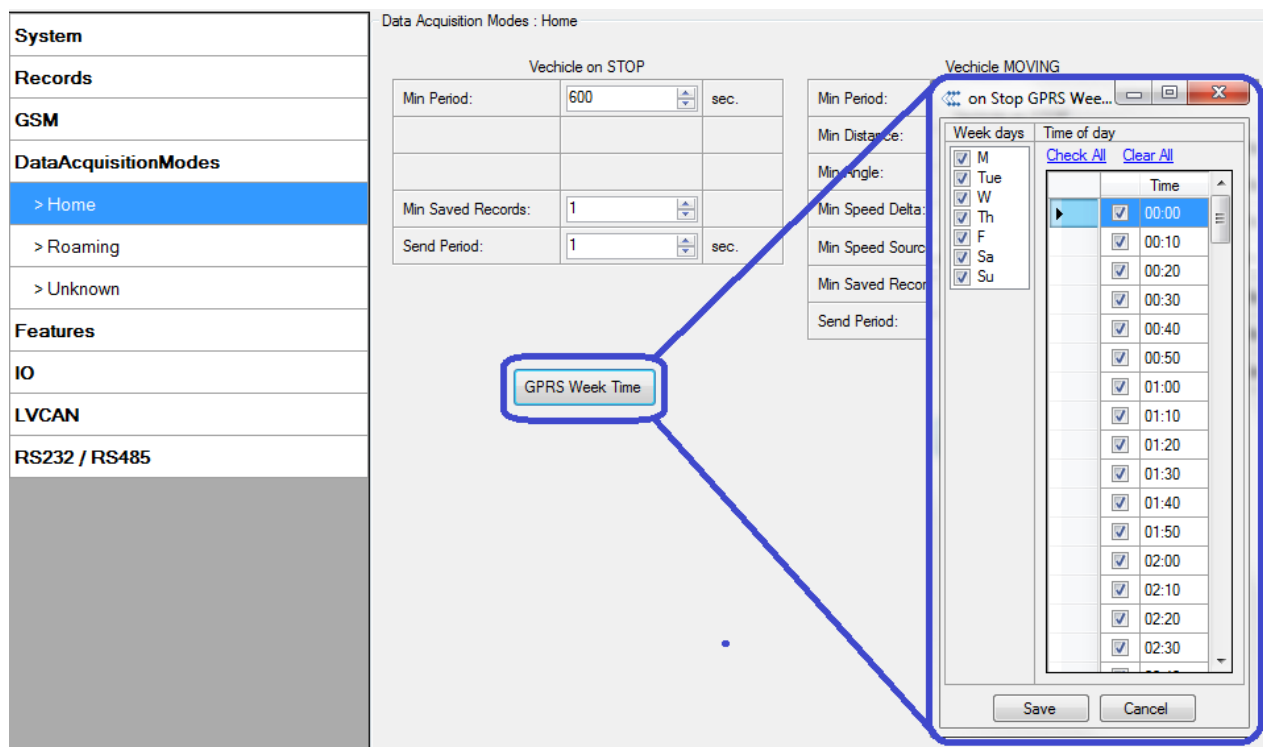

Figure 28 GPRS Week Time configuration

Device checks if the time between last saved record and current time is equal or higher than Time based acquire interval. If so, FMA110 saves record to memory. If not, FMA110 checks if the distance from last record to current record is equal or higher than Distance based acquire interval. If so, saves the record to memory. If not and speed is higher than 10km/h, then FMA110 checks if angle difference between last record and current record is equal or higher than Angle based acquire value. If so, saves the record to memory. These checks are performed every second.



Note: Keep in mind that FMA110 operates in **GMT:0** time zone, without daylight saving.

FMA110 is able to collect records using three methods at the same time: time, distance and angle based data acquisition:

Time based data acquiring (Min. period) – records are being acquired every time when defined interval of time passes. Entering zero disables data acquisition depending on time.

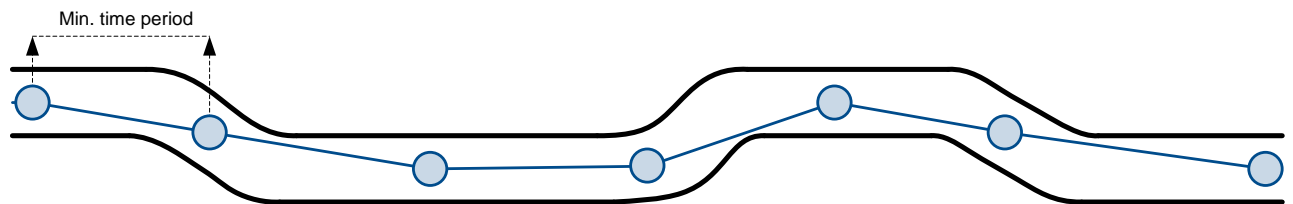

Figure 29 Time based data acquiring example

Distance based data acquiring (Min. distance) – records are being acquired when the distance between previous coordinate and current position is greater than defined parameter value. Entering zero disables data acquisition depending on distance.

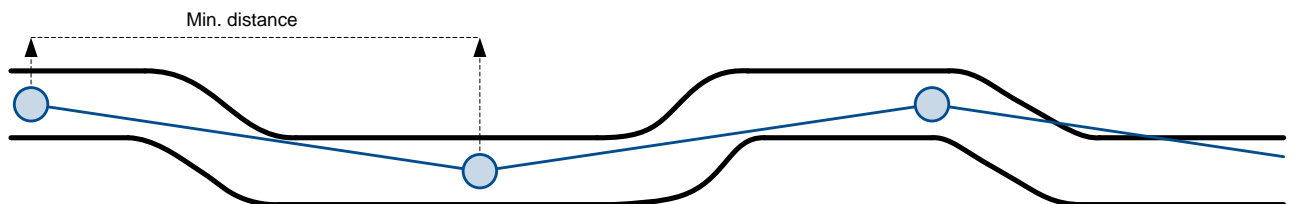

Figure 30 Distance based data acquiring example

Angle based data acquiring (Min. angle) – records are being acquired when angle difference between last recorded coordinate and current position is greater than defined value. Entering zero disables data acquisition depending on angle.

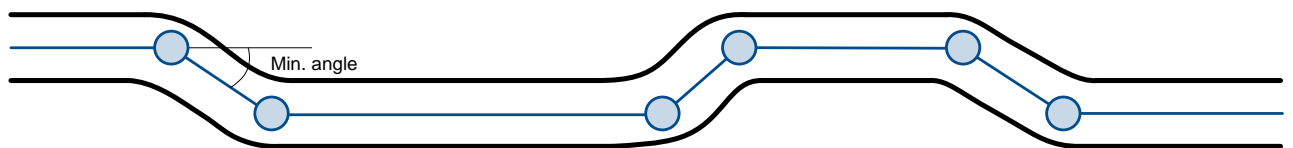

Figure 31 Angle based data acquiring example

Speed based data acquiring (Min. speed delta) – records are being acquired when speed difference between last recorded coordinate and current position is greater than defined value. Entering zero disables data acquisition depending on speed.

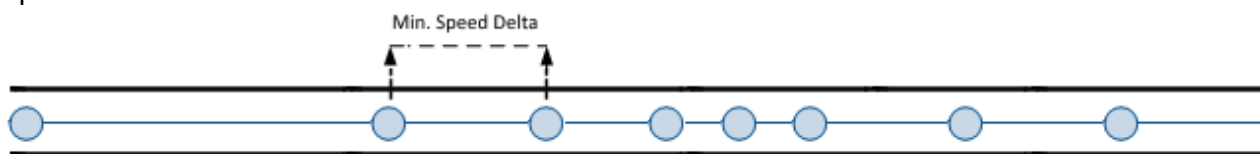

Figure 32 Speed based data acquiring example

5.14 Features settings

For more information about available Scenarios, Trip, Geofencing and iButton list, refer to 5.4 chapter.

5.14.1 Scenarios settings

In Scenarios window four different scenarios are available to use. More than one scenario can manage the same DOUT. If *DOUT Control* is disabled, scenarios can only generate events without digital output activation.

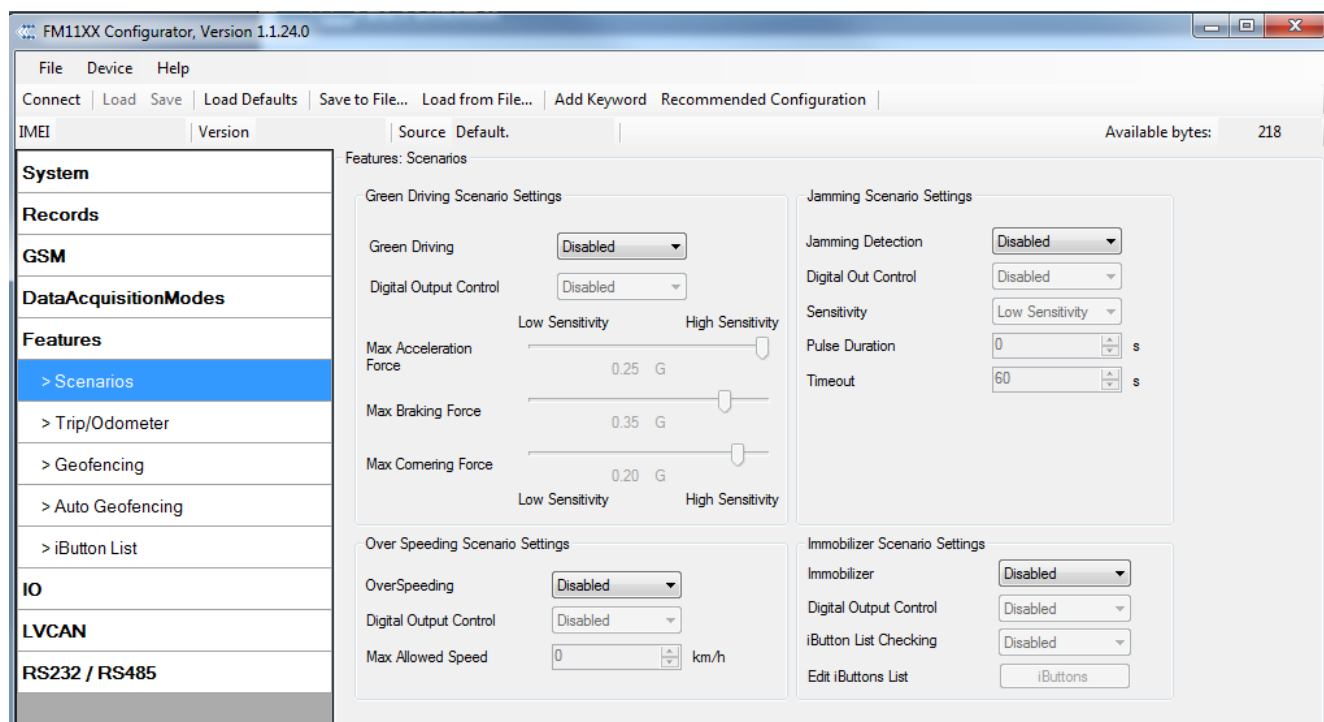

Figure 33 Scenarios configuration

Digital Output (open drain grade) usage in scenarios:

- Green Driving
 - DOUT1/DOUT2 (optional) is ON for:
 - 3sec. if detected value is over (0; 30] % from preconfigured allowed value
 - 5sec. if detected value is over (30; 50] % from preconfigured allowed value
 - 7sec. if detected value is over (50; -] % from preconfigured allowed value
 - After period of time DOUT1/DOUT2 is turned OFF.

- Over Speeding

If *Dout Control* is disabled, scenario only generate events without digital output activation. If *Dout Control* is enabled DOUT1/DOUT2 (optional) is ON, while vehicle speed exceeds the parameter value. DOUT1/DOUT2 remains active until current speed decreases below the parameter value.

- Jamming Detection

When this scenario is enabled and device modem is being jammed, then a low priority event is generated. Jamming functionality allows to set *Jamming Sensitivity* to Low, Medium or High. *Jamming Timeout*, *Jamming Dout control* and *Jamming Pulse Duration* can be configured. If *Jamming Pulse Duration* is > 0, then jamming is activated (digital output will be activated for this time period and will be deactivated after time expires). If jamming ends before this timeout occurs, then digital output will be deactivated and timeout countdown will reset. Jamming can be deactivated with iButton. When jamming event is detected and DOUT is activated it can be deactivated with iButton. If iButton list is not empty, then digital output can be deactivated only with authorized iButton.

- Immobilizer

If *Dout Control* is disabled, scenario will only generate events without digital output activation. If *Dout Control* is enabled DOUT1/DOUT2 (optional) turns ON if Ignition turns ON (configured Ignition Source =1). After iButton ID is read (any iButton is attached), DOUT1/DOUT2 turns OFF. After iButton identification, Ignition (configured Ignition Source) can be turned OFF (configured Ignition Source =0) for no longer than 30 seconds, otherwise immobilizer must be repeated. If iButton list checking parameter is enabled, authorization will be successful only if attached iButton is specified in the iButton list.

5.14.2 Trip settings

Trip window offers user to configure Trip feature. If Trip is enabled following parameters are configurable:

- Start Speed – GPS speed has to be greater than the specified Start Speed in order to detect Trip Start.
- Ignition Off Timeout – timeout to wait if ignition (configured Ignition Source) was off, to detect Trip stop.
- Continuous distance counting – *Not* or *Continuous* can be chosen. For this feature I/O Trip distance must be enabled.

If I/O *Trip distance* is enabled and Continuous distance counting variable is set to Continuous, **Trip distance** is going to be counted continuously (**from Trip start to Trip stop**). This value is written to I/O *Trip distance* value field. When Trip is over and next Trip begins, *Trip distance* value is reset to zero. When the next trip starts counting continuously starts from the beginning again.

If I/O Trip distance is enabled and Continuous Distance Counting variable is set “Not”, then the distance is going to be counted only between every record made. This value is written to I/O *Trip distance* value field and reset to zero every new record until Trip stops. If later all *Trip distance* values are summed up manually, the user gets the distance driven during the whole period of the Trip.

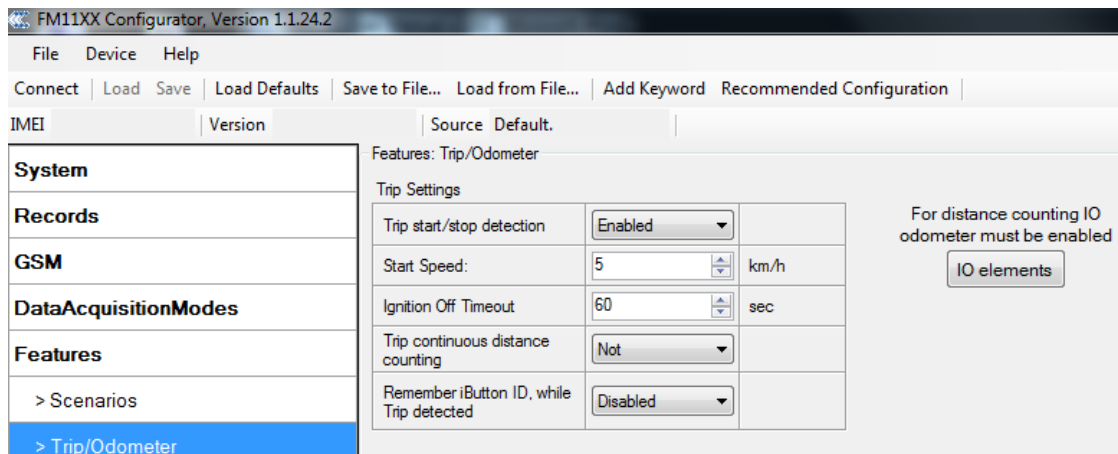

Figure 34 Trip configuration

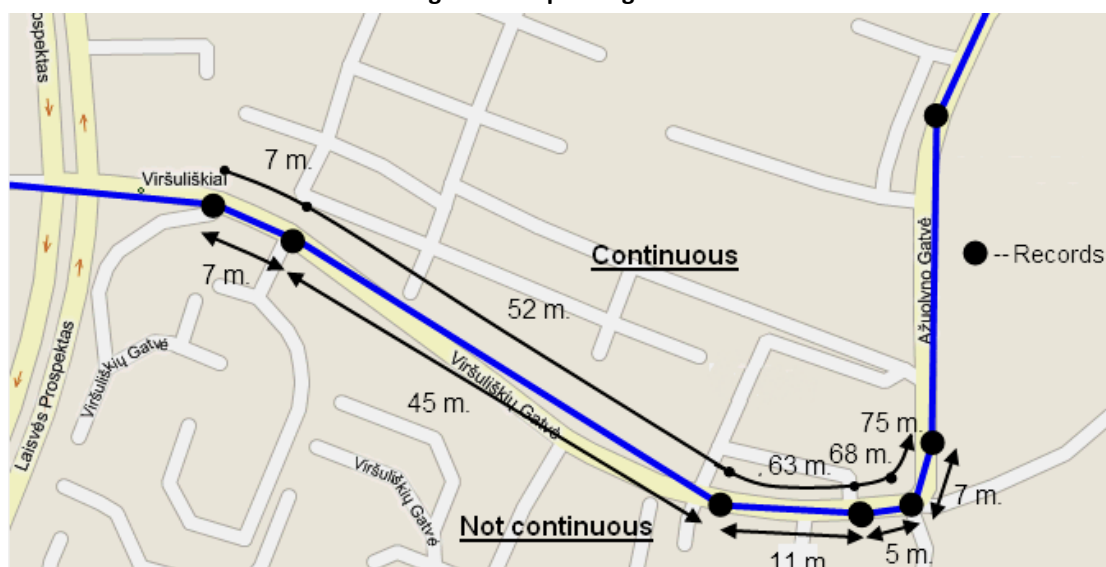

Figure 35 Trip continuous distance counting parameter example

Continuous odometer. Continuous odometer calculates the distance if *Total Distance I/O* element is enabled. Odometer Value is constantly saved to flash memory every 30 seconds, but counted every second. After power is turned off, odometer value saved in flash does not reset. *Start odometer* value with can be set using configurator („set“ button) or SMS/GPRS (setparam/getparam) commands. This parameter can not be configured via TCP config. If this value is not set, FMA110 starts counting from 0. Continuous odometer works irrespective of the Trip functionality.

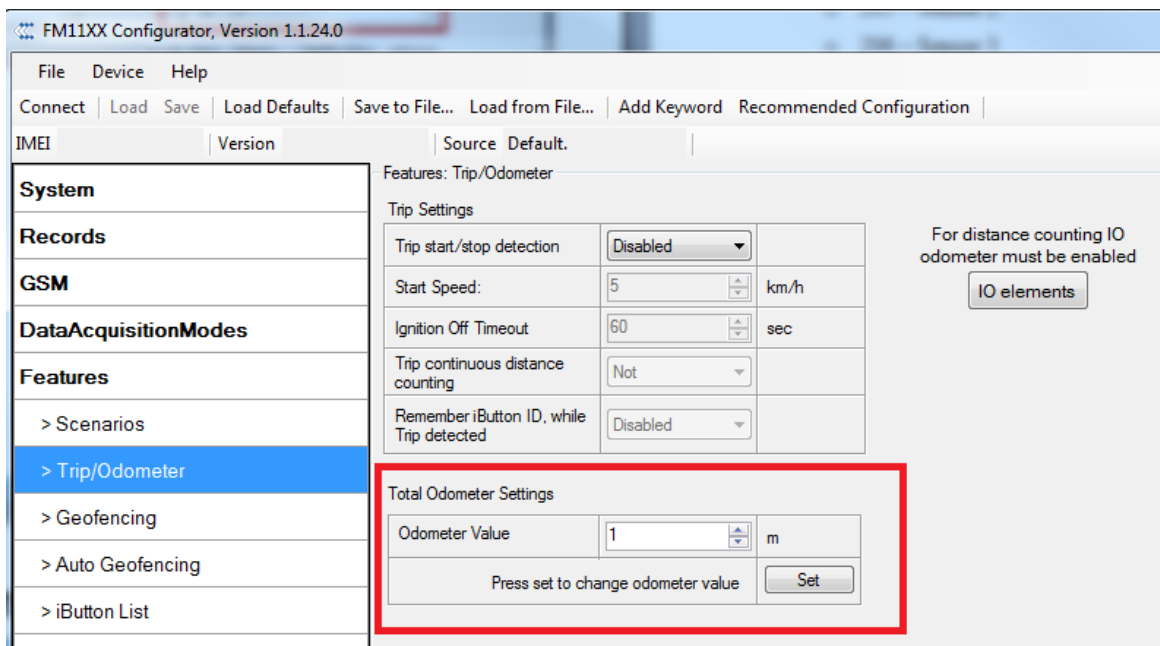

Figure 36 Continuous odometer setting in configurator.

Remember iButton functionality. If *Remember iButton ID while trip detected* and *Trip* parameters are enabled, ignition is on and iButton is attached, then FMA110 remembers iButton ID. iButton ID is saved and sent to server with every record. If new iButton is attached during the trip, FMA110 remembers new iButton ID. FMA110 forgets iButton ID after ignition is off and trip ignition off timeout is reached.

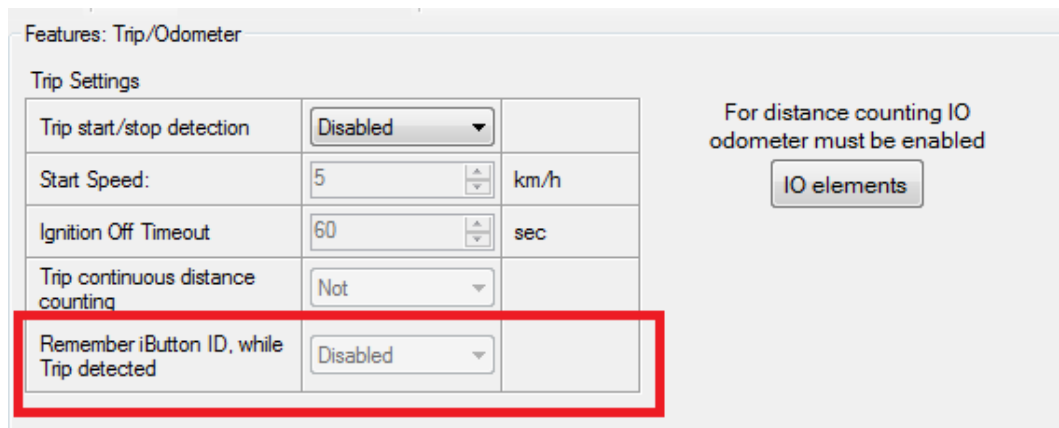

Figure 37 Remember iButton parameter in configurator

5.14.3 Geofencing settings

FMA110 has 5 configurable Geofence zones and it can generate an event when defined Geofence zone border is crossed.

Frame border – frame border is an additional border around Geofence zone. It is additional area around defined zone used to prevent false event recording when object stops on the border of the area and because of GPS errors some records are made inside area and some – outside. Event is generated only when both borders are crossed. See figure 31 for details: track 1 is considered to have entered the area while track 2 is not.

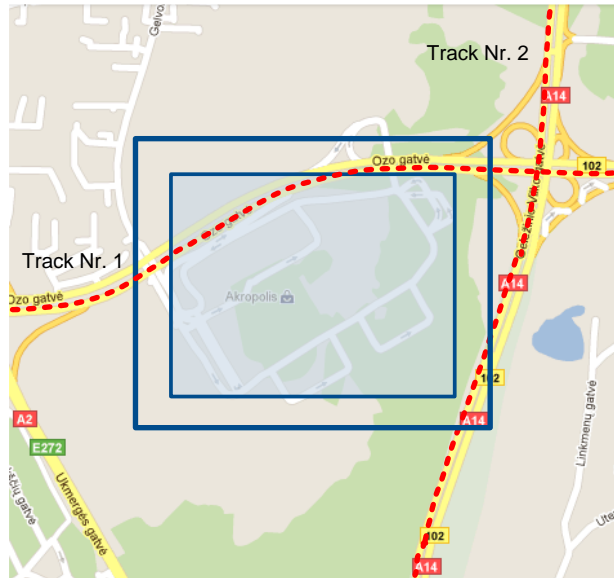

Figure 36 Geofence border

Shape – can be rectangle or circle

Priority – priority of Geofence event: low, high or panic. These levels define priority of event information sending to server. See I/O element description for more details about priorities.

Generate event (On entrance, On exit, On Both) – choose when record will be generated;

X1 – geofence zone left bottom corner X coordinate (longitude);

Y1 – geofence zone left bottom corner Y coordinate (latitude);

X2 or R – geofence zone upper right corner X coordinate (longitude) or radius of circle when Circular zone is used (radius in meters);

Y2 – geofence zone upper right corner Y coordinate (latitude);

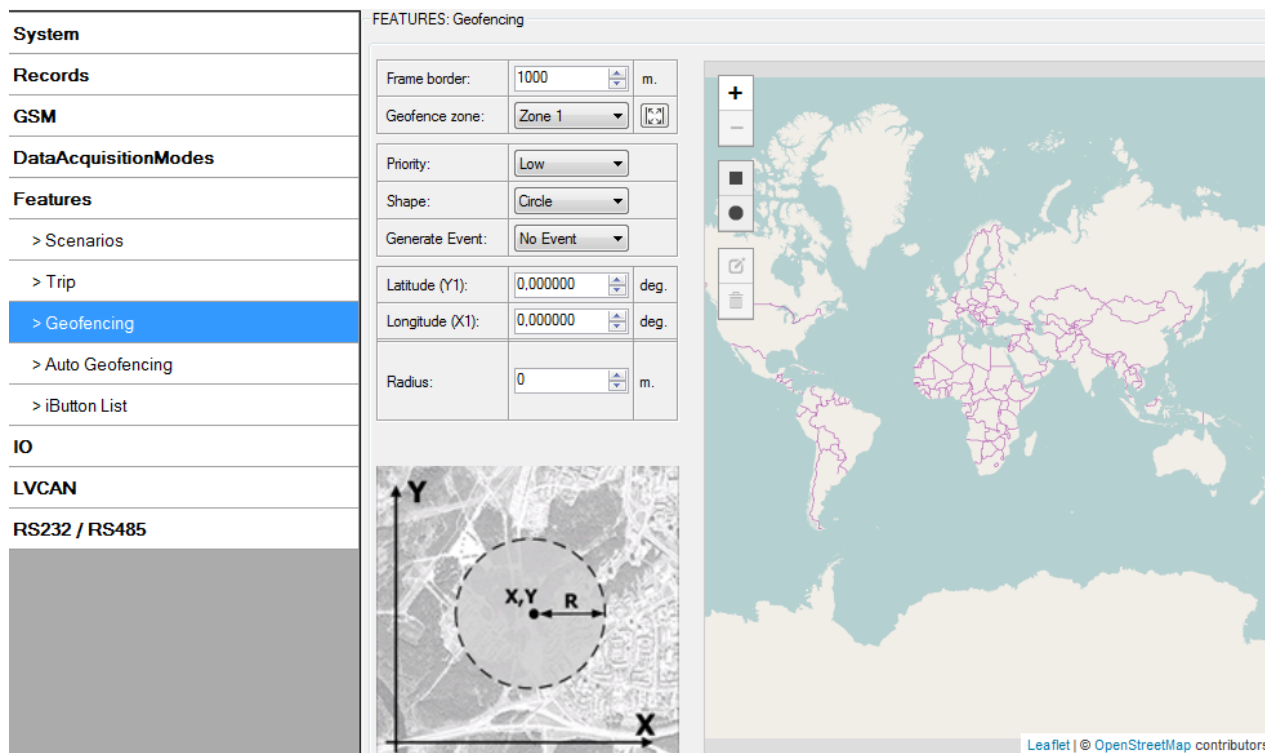

Figure 37 Geofence configuration

AutoGeofencing settings

AutoGeofence – the last known position after movement = off. If your car's being taken away – you can be notified. The shape and size of the geofence zones are parameters. It is possible to state whether entering in or out of the geofence triggers an asynchronous message.

AutoGeofencing option can be configured by following parameters visible in figure 33 below.

Activate – Enable or Disable AutoGeofence functionality.

Activation TMO – Time period before Geofence is activated after vehicle stops.

Deactivate By:

Ignition – If ignition (configured Ignition Source) becomes high it will disable AutoGeofence Zone.

IButton – if iButton is attached it will disable AutoGeofence Zone.

Edit iButton List – if list is not empty, attached iButton is tested against an iButton list, if match is found AutoGeofence zone is disabled.

Priority – Priority of generated event, which will be applied to saved record.

Enter Event – Event generation on Geofence entrance.

Exit Event – Event generation on Geofence exit.

On Both – Event generation on Geofence entrance Or exit

Note that AutoGeofencing does not require entering coordinates, instead it requires GPS visibility. If vehicle stopped and activation timeout has passed, an AutoGeofence will be created around vehicle's last position with set Radius value. AutoGeofence event generation works the same as Geofencing mentioned above.

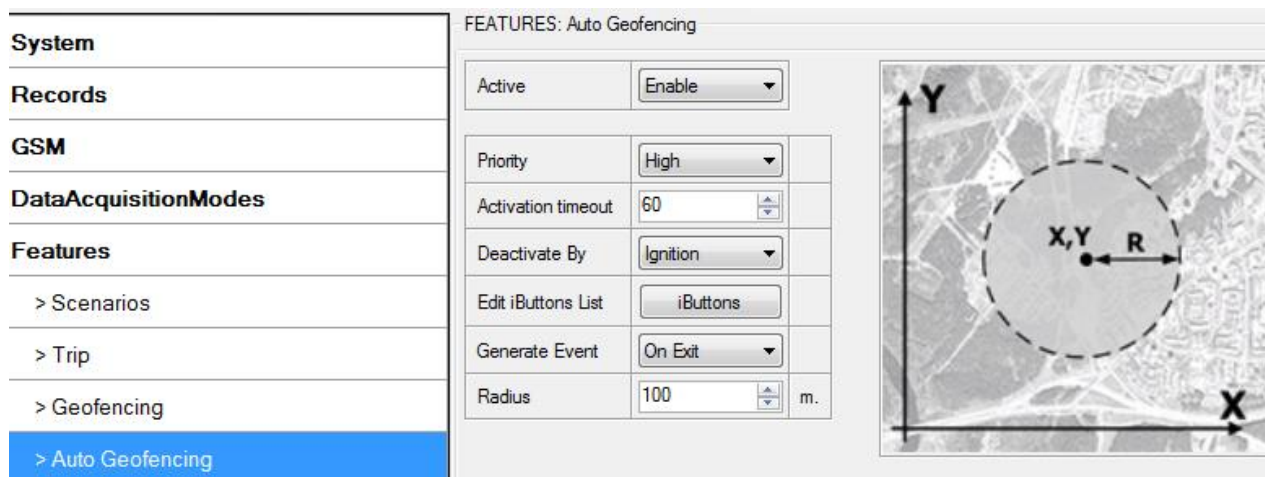

Figure 38 Geofence configuration



Note: FMA110 operates GMT:0 time without daylight saving.

5.14.4 SMS events

SMS events functionality allows FMA110 to send a configured SMS when an event is triggered. This event can be triggered by:

- Green Driving
- OverSpeeding
- Authorized Driving
- Immobilizer
- Trip start/stop
- Geofence
- AutoGeofence
- I/O event

When any of the above events is triggered, FMA110 sends a configured SMS message to a defined phone number. If SMS events is activated, but there are no numbers defined in SMS events PreDefined Numbers list (figure 34), then the device will not send any messages.

SMS events can be activated in FM11YX configurator GSM → SMS → SMS events (figure 34).

Figure 39 SMS Events PreDefined Numbers list and SMS events activation settings

The sent SMS messages format is according to:

“Date Time EventText”

For example, if FMA110 is configured to send an SMS, when Digital Input 1 reaches High level, with priority High and configured to generate event on both range enter and exit (figure 35), then the sent SMS is:

“2012/6/7 12:00:00 Digital Input 1”

Description	Enable	SMS Number	SMS Text
Digital input 1	<input checked="" type="checkbox"/>		Digital Input 1
Digital input 2	<input type="checkbox"/>		Digital Input 2
Digital input 3	<input type="checkbox"/>		Digital Input 3
Analog input 1	<input type="checkbox"/>		Analog Input 1
Digital output 1	<input type="checkbox"/>		Digital Output 1
Digital output 2	<input type="checkbox"/>		Digital Output 2
GNSS PDOP	<input type="checkbox"/>		GNSS PDOP
GNSS HDOP	<input type="checkbox"/>		GNSS HDOP

Figure 40 Configured Digital Input 1 SMS event

The SMS Text field can be altered and any text can be entered. Maximum message length is 90 symbols (numbers, letters and symbols in ASCII, except for comma “,”).



ATTENTION!

If FMA110 is in Deep Sleep mode and SMS event occurs with LOW priority (which does not wake up FMA110), then the device does not send the message. It is saved in device memory until it wakes up from Deep Sleep mode and GSM modem starts working normally. After it wakes up, all the messages that are

saved in memory will be sent, but keep in mind that only 10 messages can be saved in memory – all other messages will not be saved, until there is room in device memory.

5.14.4.1 SMS events configuration

Scenarios

To configure SMS events for scenarios, open Scenarios window and Enable desired scenario. Then go to GSM ->SMS -> SMS events window and activate SMS event for Enabled scenario. Figure 36 shows how to enable Green Driving and Authorized Driving SMS Events. After enabling SMS events, different message texts can be written for different scenarios.

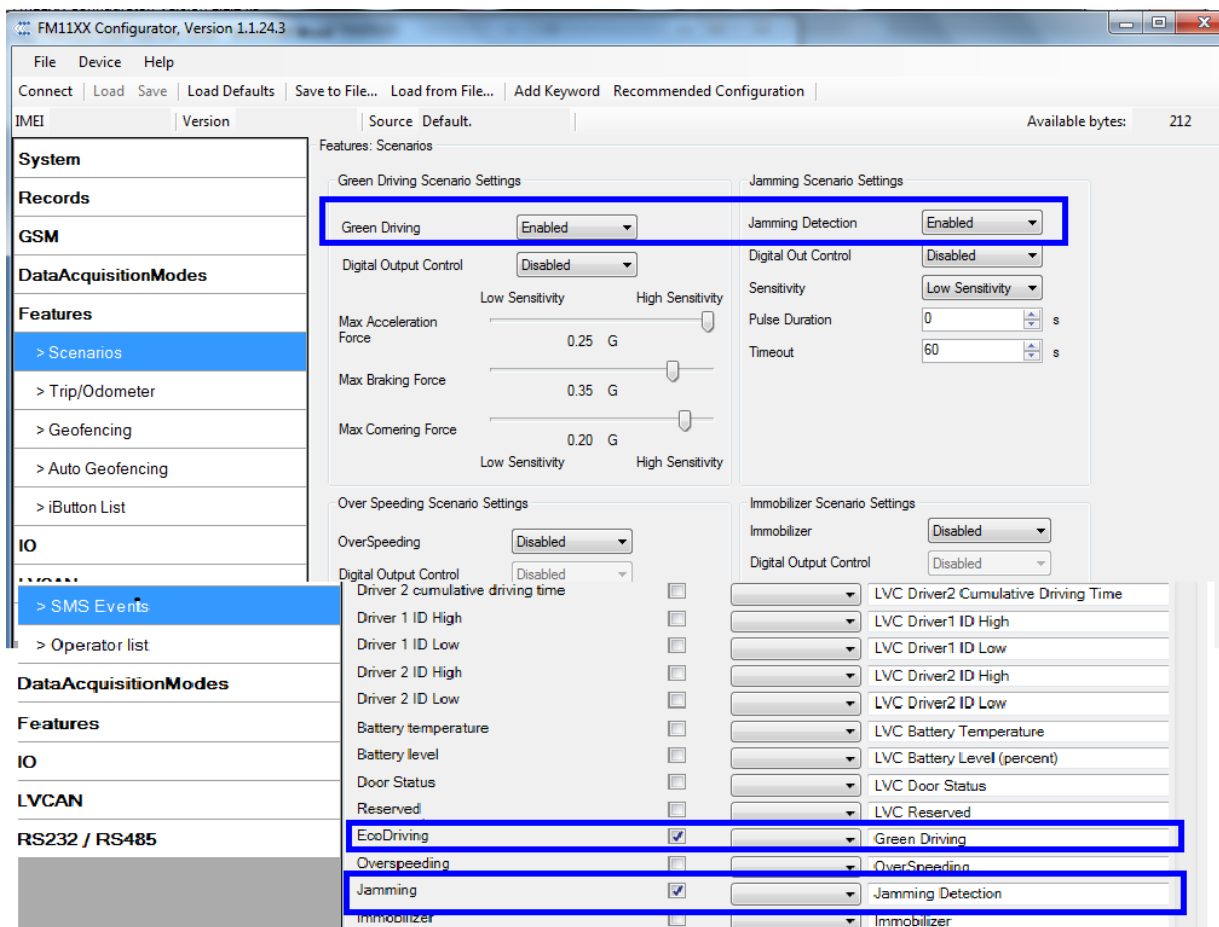

Figure 41 Scenarios SMS event configuration

When any of the scenarios events occurs, a text message will be sent to the predefined number.

Trip

In order to configure Trip SMS events click on Trip window and Enable Trip feature (figure 37). Then go to GSM -> SMS -> SMS Events settings and Enable Trip SMS event. After enabling SMS Events (figure 38), trip event will be triggered and message sent, when Trip starts (GNSS speed

exceeds the speed in Start Speed (ex. 5 km/h) and when Trip stops, that is ignition is turned off longer then the time written in Ignition Off Timeout (ex. 60 seconds).

System	Features: TRIP		
Records	TRIP START STOP DETECTION		
GSM	<input type="checkbox"/>	Enable	
DataAcquisitionModes	Start Speed:	5	km/h
Features	Ignition Off Timeout	60	sec
> Scenarios	Trip continuous distance counting	Not	
> Trip	For distance counting IO odometer must be enabled <input type="button" value="IO elements"/>		

Figure 42 Trip Start/Stop SMS event configuration

SMS Events			
Description	Enable	SMS Number	SMS Text
Overspeeding	<input type="checkbox"/>	37067812345	Overspeeding
Authorized Driving	<input type="checkbox"/>	37067812345	Authorized Driving
Immobilizer	<input type="checkbox"/>	37067812345	Immobilizer
Trip	<input checked="" type="checkbox"/>	37067812345	Trip
Geofence 1	<input type="checkbox"/>	37067812345	Geofence Zone 1
Geofence 2	<input type="checkbox"/>	37067812345	Geofence Zone 2

Figure 43 Trip Start/Stop SMS event configuration

Geofence

Geofence SMS event is triggered and message sent when the device exits and/or enters a configured Geofence zone. The Geofence zone must be configured to generate an event On Exit, On Enter or On Both (figure 39). If No Event is selected, then it is not possible to turn on SMS events. If several zones are created then SMS events can be turned on separately for each zone entering different text message.

System	FEATURES: Geofencing
Records	Geofencing
GSM	Frame border: 1000 m.
DataAcquisitionModes	Geofence zone: Zone 1
Features	Shape: Circle
> Scenarios	Priority: Low
> Trip	Generate Event: On Both
> Geofencing	Latitude (Y): 0,000000
> iButton List	Longitude (X): 0,000000
	Radius: 0 m.

SMS Events			
Description	Enable	SMS Number	SMS Text
Geofence 1	<input checked="" type="checkbox"/>	37067812345	Geofence Zone 1
Geofence 2	<input type="checkbox"/>	37067812345	Geofence Zone 2
Geofence 3	<input type="checkbox"/>	37067812345	Geofence Zone 3
Geofence 4	<input type="checkbox"/>	37067812345	Geofence Zone 4
Geofence 5	<input type="checkbox"/>	37067812345	Geofence Zone 5

Figure 44 Geofence SMS event configuration

AutoGeofence

SMS events for AutoGeofence are configured the same as in Geofence. AutoGeofence is next to Geofence configuration (figure 40), for SMS events configuration, go to GSM -> SMS -> SMS Events.

System	FEATURES: Auto Geofencing
Records	Active: Enable
GSM	Priority: High
DataAcquisitionModes	Activation timeout: 60
Features	Deactivate By: Ignition
> Scenarios	Edit iButtons List: iButtons
> Trip	Generate Event: On Exit
> Geofencing	Radius: 100 m.
> Auto Geofencing	
> iButton List	

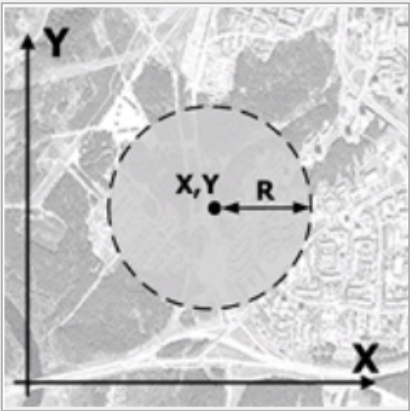

Figure 45 AutoGeofence SMS event configuration

I/O events

FMA110 sends SMS event message when a configured I/O property enters and/or exits its configured High/Low boundaries or Hysteresis event generation is chosen (Monitoring does not generate event, so SMS event could not be configured). Every IO element SMS event can be configured to send individual message to different numbers.

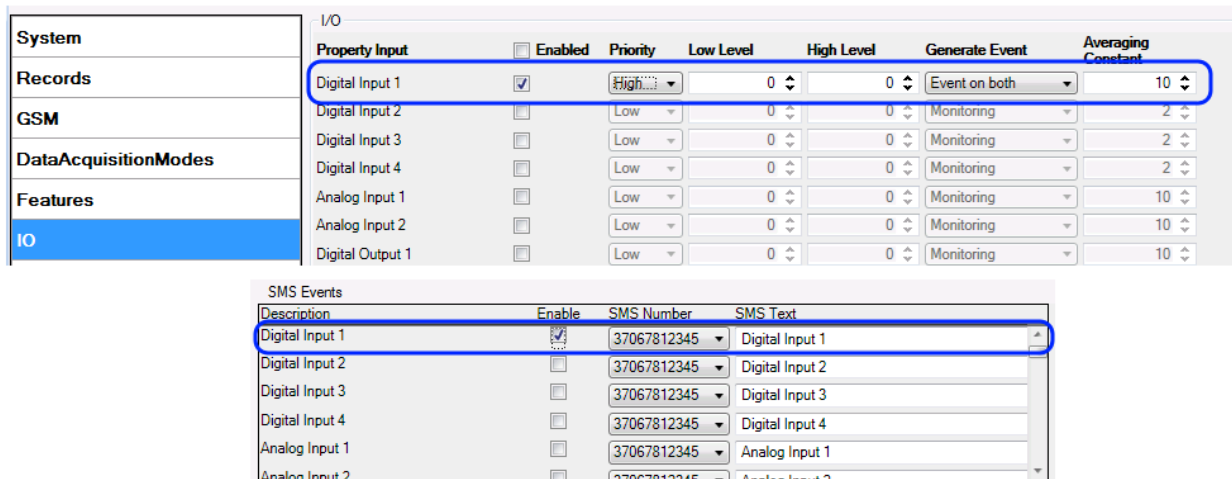

Figure 46 I/O SMS event configuration

5.15 I/O settings

When no I/O element is enabled, AVL packet comes with GPS information only. After enabling I/O element(s) AVL packet along with GPS information contains current value(s) of enabled I/O element.

Permanent I/O elements (are always sent to server if enabled)			
Nr.	Property Name	Bytes	Description
1	Digital Input Status 1	1	Logic: 0 / 1
2	Digital Input Status 2	1	Logic: 0 / 1
3	Digital Input Status 3	1	Logic: 0 / 1
4	Analog Input 1	2	Voltage: Mv, 0 – 30 V
5	GSM level	1	GSM signal level value in scale 1 – 5
6	Speed	2	Value in km/h, 0 – xxx km/h
7	External Power Voltage	2	Voltage: Mv, 0 – 30 V
8	GPS Power	2	States: 0 – GPS module is turned off, 2 – working, but no fix, 3 – working with GPS fix, 4 – GPS module is in sleep state, 5 – antenna is short circuit.
9	Dallas Temperature	4	10 * Degrees (°C), -55 - +115, if 3000 – Dallas error
10	iButton ID	8	iButton ID number
11	Data Mode	1	0 – home on stop, 1 – home on move, 2 – roaming on stop, 3 – roaming on move, 4 – unknown on stop, 5 – unknown on move
12	Digital output 1 state	1	Logic: 0 / 1

13	Digital output 2 state	1	Logic: 0 / 1
14	PDOP	2	Probability * 10; 0-500
15	HDOP	2	Probability * 10; 0-500
16	Trip distance	4	Distance between two records: m
17	Sleep mode	1	0 – not deep sleep mode, 1 – GPS sleep mode, 2 – deep sleep mode
18	Cell ID	2	GSM base station ID
19	Area Code	2	Location Area code (LAC), it depends on GSM operator. It provides unique number which assigned to a set of base GSM stations. Max value: 65536
20	Movement	1	0 – not moving, 1 – moving.
21	GSM operator Code	4	Currently used GSM Operator code
22	Ignition	1	Ignition status indication. Logic: 0 / 1
Eventual I/O elements (generate and send record to server only if appropriate conditions are met)			
Nr.	Property Name	Bytes	Description
23	Geofence zone 01	1	Event: 0 – target left zone, 1 – target entered zone
24	Geofence zone 02	1	Event: 0 – target left zone, 1 – target entered zone
25	Geofence zone 03	1	Event: 0 – target left zone, 1 – target entered zone
26	Geofence zone 04	1	Event: 0 – target left zone, 1 – target entered zone
27	Geofence zone 05	1	Event: 0 – target left zone, 1 – target entered zone
28	Auto Geofence	1	Event: 0 – target left zone, 1 – target entered zone
29	Trip	1	1 – trip start, 0 – trip stop
30	Immobilizer	1	1 – iButton connected
31	Authorized driving	1	1 – authorized iButton connected
32	Green driving type	1	1 – harsh acceleration, 2 – harsh braking, 3 – harsh cornering
33	Green driving value	1	Harsh acceleration, braking or cornering – g*100 (value 123 -> 1.23g)
34	Over Speeding	2	At over speeding start km/h, at over speeding end km/h
35	LVCAN Speed	1	Value in km/h, 0 – 250 km/h
36	LVCAN Accelerator pedal position	4	Value range: 0-100 %
37	LVCAN Total fuel used	4	Value range: 0- 99999999 liters* „Total Fuel Used“ is sent to server multiplied by 10. Example: if value was 150.5 liters, „1505“ will be sent to server.

38	LVCAN Fuel level (liters)	4	Value range: 0-100 liters
39	LVCAN Engine RPM	4	Value range: 0-8200 rpm
40	LVCAN Vehicle distance	4	Value range: 0-2145000000 meters
41	LVCAN Fuel level (proc.)	4	Value range: 0-100 %
42	LVCAN Program number	4	Value range: 0-999



There are two types of operations with Permanent I/O elements: simple monitoring and event generating. Monitoring method is used when current I/O information needed with regular GPS coordinates. Event generating method is used when additional AVL packet is needed when current value of I/O exceeds predefined High and Low levels. I/O settings allow defining I/O event criteria.

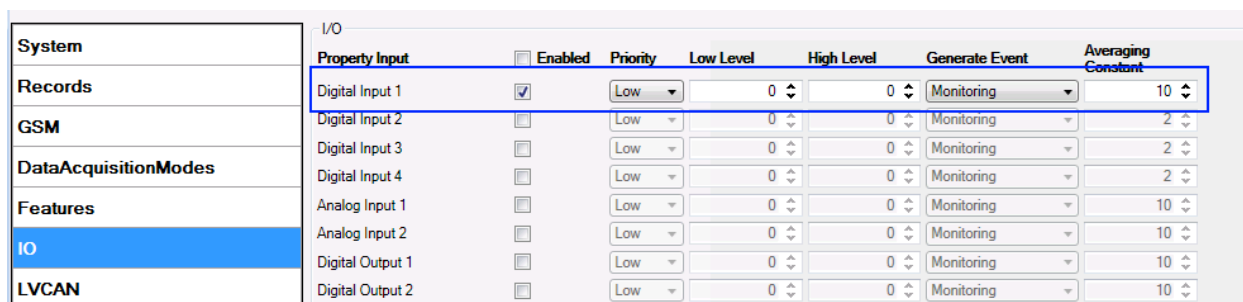

Figure 47 I/O settings

Enabled or disabled field – allows enabling I/O element so it is added to the data packet and is sent to the server. By default all I/O element are disabled and FMA110 records only GPS coordinates.

Priority (AVL packet priority) can be low, high or panic. Regular packets are sent as Low priority records. When low priority event is triggered, FMA110 makes additional record with indication that the reason for that was I/O element change. When High priority is selected, module makes additional record with high priority flag and sends event packet immediately to the server by GPRS. Panic priority triggers same actions as high priority, but if GPRS fails, it sends AVL packet using SMS mode if SMS is **enabled in SMS settings**.

High and Low levels – define I/O value range. If I/O value enters or exits this range, FMA110 generates event. “Generate event” parameter defines when to generate event – when value enters defined range, exits it or both.

Averaging constant – it is an I/O event delay parameter. In some applications there is no need to generate events on every I/O range enter/exit immediately. Sometimes it is necessary to wait some time interval before event generating. Averaging constant allows setting I/O event delay (averaging). If I/O value is entering or leaving predefined range, it must have same value for Averaging constant time. 1 Averaging constant value equals about 100 milliseconds. In Deep Sleep mode there is no Averaging.



Note: I/O element’s “Movement sensor” Averaging constant is interpreted as Start Move Timeout in seconds (from 1 to 59).

Start Move Timeout – is a time interval required for movement sensor to be in the moving state, to consider vehicle as moving.

5.15.1 Monitoring

I/O monitoring starts after enabling I/O element and setting up I/O parameters as it is shown below:

System	I/O						
Records	Property Input	Enabled	Priority	Low Level	High Level	Generate Event	Averaging Constant
	Digital Input 1	<input checked="" type="checkbox"/>	Low	0	0	Monitoring	10
	Digital Input 2	<input type="checkbox"/>	Low	0	0	Monitoring	2
	Digital Input 3	<input type="checkbox"/>	Low	0	0	Monitoring	2
	Digital Input 4	<input type="checkbox"/>	Low	0	0	Monitoring	2
	Analog Input 1	<input type="checkbox"/>	Low	0	0	Monitoring	10
	Analog Input 2	<input type="checkbox"/>	Low	0	0	Monitoring	10
	Digital Output 1	<input type="checkbox"/>	Low	0	0	Monitoring	10
	Digital Output 2	<input type="checkbox"/>	Low	0	0	Monitoring	10

Figure 48 I/O settings

5.15.2 Event Generating

Events happen when the value of enabled I/O intersects thresholds (enter, exit or on both) predefined by High and Low level thresholds. Table below defines all available values of I/O settings.

Setting	Value
Priority	low, high
High level	maximum threshold
Low level	minimum threshold
Generate event	on interval enter, on interval exit, on both enter and exit
Average constant	$1 - 2^{32}$ (4 Bytes)

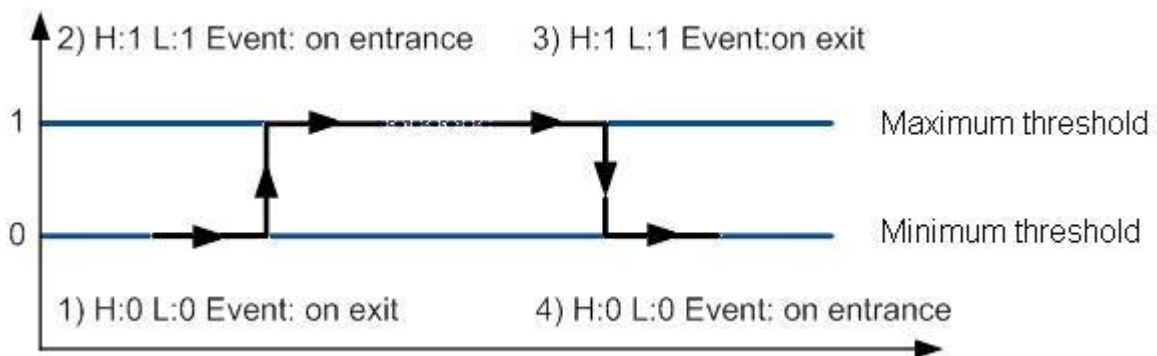

Figure 49 Digital Input event generation example

5.15.3 Hysteresis

Enabled	Priority	Low Level	High Level	Generate Event	Averaging Constant
<input checked="" type="checkbox"/>	Low	0	0	Hysteresis	10

Figure 50 Hysteresis parameter configuration

I/O elements can generate events according to hysteresis algorithm. If I/O event operand "Hysteresis" is selected, events will be generated as it is shown in the illustration below (I/O speed is taken as I/O value example):

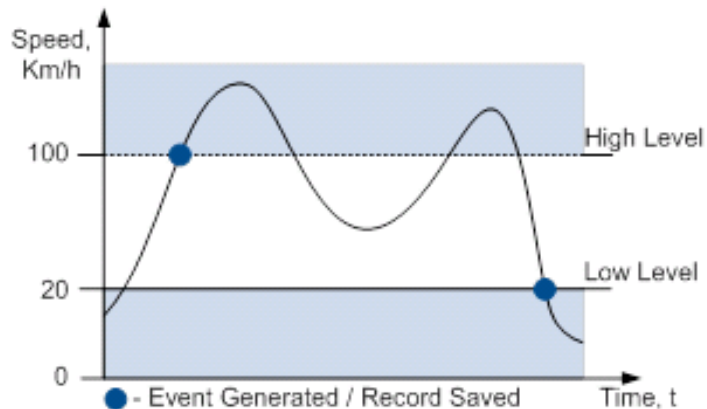

Figure 51 Event generation according hysteresis algorithm

6 SMS COMMAND LIST

Read chapter 5.11 to know how to construct a proper SMS message and send it to FMA110 device. All commands are case sensitive. While FMA110 operates in Deep Sleep mode and user tries to send SMS message it cannot arrive to FMA110 device, because GSM/GPRS module is disabled most of the time (wake up depends on Send Period parameter). FMA110 will receive the SMS when it wakes up (exits deep sleep mode).

6.1 SMS command list

Command	Description	Response
getstatus	Modem Status information	Yes
getweektime	Current device time, Day of Week and amount of minutes passed since start of week	Yes
getops	List of currently available GSM operator	Yes
getcfgtime	Date and Time of last successful configuration	Yes
getgps	Current GPS data and time	Yes
cpureset	Reset CPU	No
resetprof	Reset all FLASH1 profile configuration to default profile	No
getver	Device / Modem / Code version information	Yes
getinfo	Device runtime system information	Yes
deleterecords	Delete all records saved on FLASH	No
getio	Readout digital inputs and outputs	Yes
radio #	Readout input value according entered ID, # - ID value	Yes
setdigout ## Y1 Y2	set digital outputs 0 – OFF, 1 – ON Y1 – timeout for DO1 Y2 – timeout for DO2	Yes
setdigoutX Z Y	set selected digital output X – number of Digital output (1 – digital output 1; 2 – digital output 2)	Yes

	Z – activate(1)/deactivate(0) Y – activation/deactivation timeout	
getparam #	Readout parameter value according entered ID. # - ID value.	Yes
setparam # #	Set parameter value according entered ID and Value. 1.# - ID value. 2.# - New Parameter Value	Yes
getparam 1271 X	X values can be 1,2,3.	Yes
flush #,#,#,#,#,#,#	Initiates all data sending to specified target server 1.# - IMEI 2.# - APN 3.# - LOGIN 4.# - PASS 5.# - IP 6.# - PORT 7.# - MODE (0-TCP/1-UDP)	No
readops #	1 – send first 20 operator codes, 2 – send from 21 st to 40 th operator codes, 3 – send all other operator codes	
sn #	Static navigation, 1 – enable, 0 – disable	Yes
banlist	Banned operators information	Yes
crashlog	Device last information before unexpected reset	Yes
delete_all_sms	Deletes all SMS	No
lvcangetprog	CAN Program Number request by SMS	Yes
lvcansetprog #	Set LV-CAN program number	Yes
lvcangetinfo	Get LV-CAN info by SMS	Yes
getcontsens	Get IDs of connected temperature sensors	Yes

6.1.1 getstatus

Response details	Description
Data Link	Indicate module connection to server at the moment: 0 – Not connected, 1 – connected
GPRS	Indicate if GPRS is available at the moment
Phone	Voice Call status: 0 – ready, 1 – unavailable, 2 – unknown, 3 – ringing, 4 – call in progress, 5 – asleep
SIM	SIM Status: 0-ready, 1-pin, 2-puk, 3-pin2, 4-puk2
OP	Connected to GSM Operator: numerical id of operator
Signal	GSM Signal Quality [0-5]
NewSMS	Indicate if new message received
Roaming	0 – Home Network, 1 – roaming
SMSFull	SMS storage is full? 0 – ok, 1 – SMS storage full
LAC	GSM Tower Location Area Code
Cell ID	GSM Tower Cell ID Code

Example: Data Link: 0 GPRS: 1 Phone: 0 SIM: 0 OP: 24602 Signal: 5 NewSMS: 0 Roaming: 0 SMSFull: 0 LAC: 1 Cell ID: 864

6.1.2 getweektime

Response details	Description
Clock Sync	Indicates system clock synchronization status. 0 – System is not synchronized, 1 – System synchronized
DOW	Day Of Week – indicates current day of week starting from 1 – Monday, 2 – Tuesday, etc.
Time	Indicates current GMT time
WeekTime	Indicates time in minutes starting from Monday 00:00 GMT

Example: Clock Sync: 1 DOW: 4 Time 12:58 Weektime: 6538

6.1.3 getops

Response details	Description
LIST	Returns list of current available allowed operators.

Example: (2,"LT BITE GSM","BITE","24602"),(3,"TELE2","TELE2","24603")

6.1.4 getcfgtime

Response details	Description
Date/Time	Returns last performed configuration date and time.

Example: Last Configuration was performed on: 2010.4.15 5:45:19

6.1.5 getgps

Response details	Description
GPS	Indicates valid (1) or invalid (0) GPS data
Sat	Count of currently available satellites
Lat	Latitude (Last good Latitude)
Long	Longitude (Last good Longitude)
Alt	Altitude
Speed	Ground speed, km/h
Dir	Ground direction, degrees
Date	Current date
Time	Current GMT time

Example: GPS:1 Sat:7 Lat:54.71473 Long:25.30304 Alt:147 Speed:0 Dir:77 Date: 2007/8/24
Time: 13:4:36

6.1.6 getver

Response details	Description
Code Ver	Firmware version
Device IMEI	IMEI
Device ID	Device ID is used to detect by server which type of configuration to load
Bootloader Ver	Bootloader Version

Modem App Ver	Version of modem application (veiks: nuo 00.05.14)
Revision	Firmware revision

Example: Code Ver:01.06.15 Rev:1 Device IMEI:353976010139156 Device ID:000001
 Bootloader Ver: 01.09 Modem APP Ver:TM11Q_R_01.00.03.03_002

6.1.7 getinfo

Response details	Description
INI	Device Initialization Time
RTC	RTC Time
RST	Restart Counter
ERR	Error Counter
SR	Number of Sent Records
BR	Number of broken records
CF	Profile CRC Fail counter
FG	Failed GPRS counter
FL	Failed link counter
UT	UPD Timeout counter
SMS	Sent SMS Counter
NOGPS	No GPS Timer
GPS	GPS receiver state. 0 – OFF, 1 – restarting, 2 – ON but no fix, 3 – ON and operational, 4 – sleep mode
SAT	Average satellites
RS	Reset Source Identification 1 – Low Power, 2 – W Watchdog, 3 – I Watchdog, 4 – Software reset, 5 – Power On, 6 – Pin Reset
MD	Data Mode state. 0 – Home and Stop, 1 – Home and Moving, 2 – Roaming and Stop, 3 – Roaming and Moving, 4 – Unknown and Stop, 5 – Unknown and Moving
RF	Records Found – number of records in the memory.

Example: INI:2013/10/11 8:44 RTC:2013/10/11 8:59 RST:1 ERR:0 SR:0 BR:0 CF:0 FG:0 FL:0
 UT:0 SMS:1 NOGPS:0:14 GPS:2 SAT:0 RS:3 MD:4 RF:0

6.1.8 getio

Response details	Description
DI#	Digital Input state
AIN#	Analog Input state
DO#	Digital Output state

Example: DI1:0 DI2:0 DI3:0 AIN:0.0611 DO1:0 DO2:0

6.1.9 readio

Response details	Description
ID	I/O element ID
Value	I/O Element value

Example: I/O ID:3 Value:0

6.1.10 setdigout ## Y1 Y2

Sets digital outputs to ON or OFF state (for some time if needed). Value is written as a row for OUT1 and OUT2 values.

Example: 'setdigout 01 0 5' will set OUT2 to high level for 5 seconds, while OUT1 to low level.

To ignore one digital output value and make ON/OFF state only to another digital output any character except 0 and 1 can be used.

Example: 'setdigout ?1' will set OUT2 to high level for indefinite period of time while OUT1 remains as it was set before.

6.1.11 setdigoutX Z Y

Sets selected digital output to on or OFF state for a defined period of time.

Example: 'setdigout2 1 5' will set DOUT2 to high level for 5 seconds.

6.1.12 getparam #####

Read parameter value. ID consists of 3 or 4 digits. Detailed list of parameters and IDs can be found in chapter number 8 "Parameter List".

Example: 'getparam 1115' command will request server IP address.

6.1.13 setparam #####

Sets new value for parameter. ID consists of 3 or 4 digits. Detailed list of parameters and IDs can be found in chapter number 8 "Parameter List"

Example: 'setparam 1115 127.0.0.1' will change configured IP address.

6.1.14 getparam 1271 X/212 X

X values can be 1,2,3.

If X = 1, Operator codes from 0-19 are read from configuration and sent via SMS.

If X = 2, Operator codes from 20-39 are read from configuration and sent via SMS.

If X = 3, Operator codes from 40-49 are read from configuration and sent via SMS.

If X = any other, Operator codes from 0-19 are read from configuration and sent via SMS.

6.1.15 setparam 1271 X/212 X

If X is from 0 to 49, X means index of operator code which has to be configured. Up to 20 operator codes may be configured in 1 SMS. Example: *Setparam 1271 16 24602,24603,24605* ,here 16th, 17th and 18th operator codes are set. Note! Other operator codes are left unchanged in the configuration.

6.1.16 readops #

Send from device Operator List.

1 – send first 20 operator codes, 2 – send from 21st to 40th operator codes, 3 – send all other operator codes.

6.1.17 flush #,#,#,#,#,#

Initiates all data sending by GPRS to specified target server. Comma separated parameters go as numbered:

- 1.# - IMEI
- 2.# - APN
- 3.# - GPRS LOGIN
- 4.# - GPRS PASSWORD
- 5.# - IP
- 6.# - PORT
- 7.# - MODE (0-TCP/1-UDP)

Parameters are separated by comma (no spaces needed). In case you don't need to enter parameter (Login/Pass) – do not put space, simply put comma and write next parameter.

Example: opa opa flush 353976012555151,banga,,,212.47.99.62,12050,0

Response details	Description
FLUSH SMS Accepted	FLUSH SMS Accepted
# records found on FLASH	Number of records found on FLASH
Minimum Records to Send: #	Number of minimum saved records to send
GPRS Enabled: #	State of the GPRS connection, 0 – disabled; 1 – enabled
Time Sync: #	Indicates time synchronization on the device, 0 – not synchronized; 1 – synchronized

Example: FLUSH SMS Accepted. 11 records found on FLASH. Minimum Records to Send: 1. GPRS Enabled: 1. Time Sync: 1.

6.1.18 sn

Enables or disables Static navigation. 1 – enable, 0 – disable.

6.1.19 banlist

Gives a list of all banned operators.

Example when no operators are banned: 0000.00s.0.000

6.1.20 crashlog

Gives the last information before the device has crashed for unexpected reasons. It is useful when the device acts unexpectedly or restarts for unexplained reasons.

Example if no unexpected reset: "Crash: "

Example if unexpected reset was detected: "Crash: 3051,3052,3053".

6.1.21 lvcangetprog

CAN program number can be obtained via SMS:

SMS Text: "lvcangetprog"

Response: "CAN Program Nr: XXXX"

6.1.22 lvcansetprog

Set LV-CAN program number via SMS:

SMS Text: "lvcansetprog 139"

Response: "CAN program Nr:139"

6.1.23 lvcngetinfo

Get LV-CAN info by SMS

Full LV-CAN information via SMS:

SMS Text: " lvcngetinfo"

Response: "

Prog: 139

SWRevison: 6

KernVer: 10

KernVar: 49

MdlID: 8884443332221110"

7 Debug mode

FMA110 is able to transmit its current state when connected to PC using USB cable. It is used to detect errors and provide information to possible solutions when operating as unexpected. Download Terminal from:

<http://av1.teltonika.it/Downloads/Software/Terminal.zip>.

After launching terminal choose baud rate 115200 and hardware control – none. Select COM port which is assigned to "Virtual COM Port". Click on 'Start Log' button and save a new file. Then click 'Connect' to start receiving messages from FMA110.

Also you can log NMEA data directly. To get NMEA data, simply enter the following command into the command field: **.log_nmea:1\$0a**.

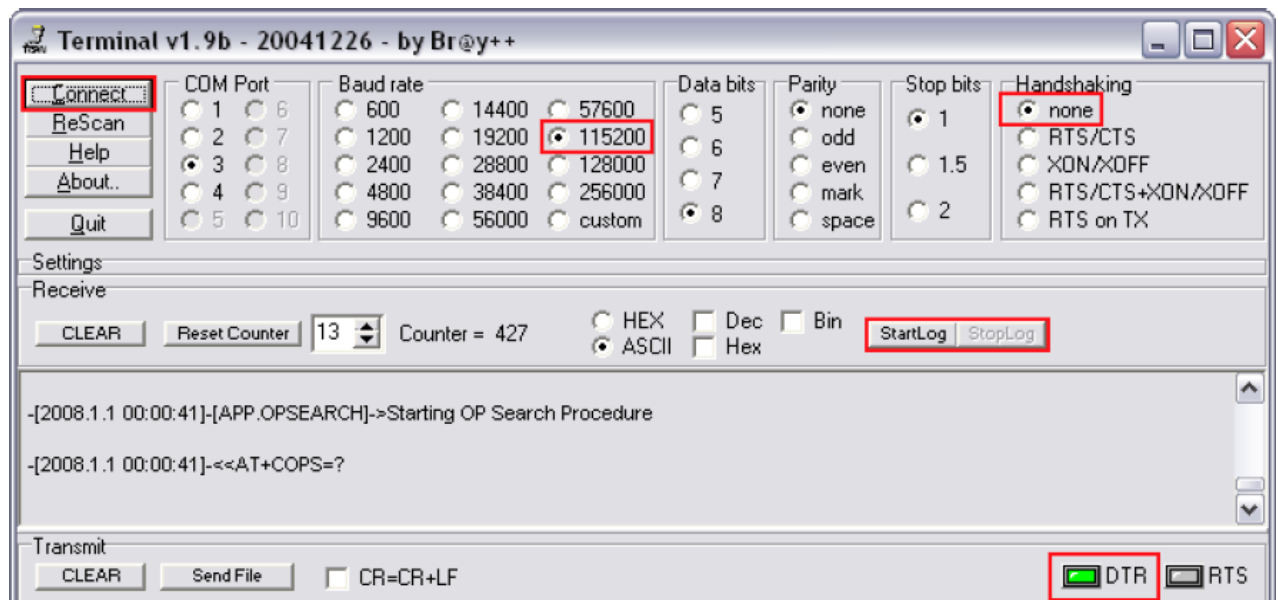

Figure 52 Terminal window for logging

8 Parameter List

8.1 Parameters value types

- S8 – Signed Char
- S8[n] – String of *n* Char
- U8 – Unsigned Char
- U16 – Unsigned Short
- S32 – Signed Integer
- U32 – Unsigned Integer
- U64 – Unsigned Long Long Integer

8.2 System parameters

8.2.1 Sleep Mode (ID=1000)

Device has two sleep modes: sleep and deep sleep mode. While sleep is disabled (value 0) module will never enter sleep mode, in sleep mode (value 1) module reduces level of power usage by turning GPS module to sleep, in deep sleep mode (value 2) module turns GPS module to sleep and switch GSM module off (note, that FMA110 do not receive SMS while in deep sleep).

Minimum value	Maximum value	Recommended value	Goes with (depends on) parameters	Value type
0	2	-		U8

8.2.2 Sleep timeout (ID=200)

Sleep timeout is time after which FMA110 goes to sleep or deep sleep if other requirements are met. It is measured in minutes.

Minimum value	Maximum value	Recommended value	Goes with (depends on) parameters	Value type
1	3000	-		U8

8.2.3 Analog Input value range (ID=1001)

Analog input measuring resolution and range can be defined as 0...10V (value 0) or 1...30V (value 1).

Minimum value	Maximum value	Recommended value	Goes with (depends on) parameters	Value type
0	1	-		U8

8.2.4 Stop Detection Source (ID=1002)

Device can operate and change its working mode according to motion detection source: ignition (value 0), movement sensor (value 1), GPS (value 2).

Minimum value	Maximum value	Recommended value	Goes with (depends on) parameters	Value type
0	2	-		U8

8.2.5 Static Navigation (ID=1003)

When static navigation is enabled, FMA110 filters out GPS jumps, when it is not moving. When it is disabled, it does not make any changes to collected GPS data.

Minimum value	Maximum value	Recommended value	Goes with (depends on) parameters	Value type
0	1	1		U8

8.2.6 Ignition source (ID=1004)

Device can operate and change its working mode according to motion detection source: Power Voltage (value 0), Digital Input 1 (value 1), movement (value 2).

Minimum value	Maximum value	Recommended value	Goes with (depends on) parameters	Value type
0	2	-	Power Voltage High Level (ID=1005) Power Voltage Low Level (ID=1006)	U8

8.2.7 Power Voltage High Level (ID=1005)

When ignition source is selected as Power Voltage High level for ignition detection must be set.

Minimum value	Maximum value	Recommended value	Goes with (depends on) parameters	Value type
0	30000	-	Ignition source (ID=1004) Power Voltage Low Level (ID=1006)	U16

8.2.8 Power Voltage Low Level (ID=1006)

When ignition source is selected as Power Voltage High level for ignition detection must be set.

Minimum value	Maximum value	Recommended value	Goes with (depends on) parameters	Value type
0	30000	-	Ignition source (ID=1004) Power Voltage High Level (ID=1005)	U16

8.2.9 Saving/Sending without time synchronization (ID=201)

When this feature is enabled (value = 1), then records can be saved and sent to server without time synchronization.

Minimum value	Maximum value	Recommended value	Goes with (depends on) parameters	Value type
0	1	1		U8

8.2.10 GNSS System (ID=202)

This parameter sets Satellite System, available values: 0 – GNSS (all available); 1 – GPS only; 2 – GLONASS only.

Minimum value	Maximum value	Recommended value	Goes with (depends on) parameters	Value type
0	2	0		U8

8.2.11 GNSS fix Timeout (ID=1007)

This parameters defines GNSS fix Timeout for time synchronization via NTP.

Minimum value	Maximum value	Recommended value	Goes with (depends on) parameters	Value type
1	259200	-		U8

8.2.12 NTP Time Synchronization (ID=1008)

This parameter Enables/Disables time synchronization from NTP server when there is no valid GPS signal from satellites, available values: 0 – disabled, 1 – enabled.

Minimum value	Maximum value	Recommended value	Goes with (depends on) parameters	Value type
0	1	1		U8

8.3 Records parameters

8.3.1 8.3.1 Sorting (ID=1010)

Record sorting parameter is responsible for record sorting order. Value of 0 arranging data starting from newest, while value of 1 arranging data starting from oldest.

Minimum value	Maximum value	Recommended value	Goes with (depends on) parameters	Value type
0	1	-		U8

8.3.2 8.3.2 Active Data Link Timeout (ID=1011)

Defines for how many seconds device will keep connection to the server after successful data transfer while waiting for a new record.

Minimum value	Maximum value	Recommended value	Goes with (depends on) parameters	Value type
0	259200	-		U32

8.3.3 8.3.3 Server Response Timeout (ID=1012)

Defines time period (in seconds) for server response to sent records.

Minimum value	Maximum value	Recommended value	Goes with (depends on) parameters	Value type
1	300	-		U8



ATTENTION! Some GSM operators may disconnect the device from an active data link if the device doesn't send any data for a very long time, even if active data link timeout is set to maximum value. The amount of time that an operator keeps the link open depends solely on the operator. For example, if active data link timeout is set to maximum, 259200 seconds (72 hours), and the device sends data to server every 86400 seconds (24 hours), the operator might disconnect the link earlier and the device will have to connect to the server anew. This may cost extra, depending on the operator GPRS data charge. It is strongly recommended, when using active data link timeout, that data sending to the server should not be very rare (24 hours or more). If data sending is more frequent, then the operator will not disconnect the device from the server.

8.4 GSM parameters

8.4.1 GPRS content activation (ID=1240)

Parameter allows or does not allow GPRS usage. If GPRS is not allowed value is 0, if GPRS is allowed value is 1.

Minimum value	Maximum value	Recommended value	Goes with (depends on) parameters	Value type
0	1	-	APN Name (ID=1242) APN username (ID=1243) APN Password (ID=1244)	S8

8.4.2 APN Name (ID=1242)

Parameter defines GPRS Access Point Name.

Minimum value	Maximum value	Recommended value	Goes with (depends on) parameters	Value type
Empty	32 char string	-	GPRS content activation (ID=1240) APN username (ID=1243) APN Password (ID=1244)	S8[32]

8.4.3 APN username (ID=1243)

Parameter defines APN username. In case operator does not use username for login, value should be empty.

Minimum value	Maximum value	Recommended value	Goes with (depends on) parameters	Value type
Empty	30 char string	-	GPRS content activation (ID=1240) APN Name (ID=1242) APN Password (ID=1244)	S8[30]

8.4.4 APN Password (ID=1244)

Parameter defines APN password. In case operator does not use password for login, value should be empty.

Minimum value	Maximum value	Recommended value	Goes with (depends on) parameters	Value type
Empty	30 char string	-	GPRS content activation (ID=1240) APN Name (ID=1242) APN username (ID=1243)	S8[30]

8.4.5 Domain (ID=1245)

Parameter defines AVL data destination server IP address. Example: 212.47.99.62

Minimum value	Maximum value	Recommended value	Goes with (depends on) parameters	Value type
0	31 char string	-	GPRS content activation (ID=1240) Domain (ID=1245)	S8[16]

8.4.6 Target Server Port (ID=1246)

Parameter defines AVL data destination server port number. Example: 12050

Minimum value	Maximum value	Recommended value	Goes with (depends on) parameters	Value type
Empty	65535	-	GPRS content activation (ID=1240) Target Server Port (ID=1246)	U16

8.4.7 Protocol (ID=1247)

Parameter defines GPRS data transport protocol. Module can use TCP or UDP transport protocol to send data to server. For TCP protocol value is 0, for UDP protocol value is 1.

Minimum value	Maximum value	Recommended value	Goes with (depends on) parameters	Value type
0	1	-	GPRS content activation (ID=1240)	U8

8.4.8 Always online (ID=1248)

Parameter allows keeping the link with a server open all the time. If Always online mode is not allowed value is 0, if it is allowed value is 1.

Minimum value	Maximum value	Recommended value	Goes with (depends on) parameters	Value type
0	1	-		S8

8.4.9 SMS Login (ID=1252)

User login is used to ensure module security. Used in every SMS that is sent to device. Example: ba321

Minimum value	Maximum value	Recommended value	Goes with (depends on) parameters	Value type
Empty	5 char	-	SMS Password (ID=1253)	S8[5]

8.4.10 SMS Password (ID=1253)

User password is used to ensure module security. Used in every SMS that is sent to device.
Example: ab123

Minimum value	Maximum value	Recommended value	Goes with (depends on) parameters	Value type
Empty	5 char	-	SMS Login (ID=1252)	S8[5]

8.4.11 SMS data sending settings (ID=1250)

Parameter allows or does not allow sending AVL data using binary SMS. If SMS use is not allowed value is 0 and 1 if SMS use is allowed.

Minimum value	Maximum value	Recommended value	Goes with (depends on) parameters	Value type
0	1	-	SMS Data send week time schedule (ID=1273)	S8

8.4.12 SMS Data send week time schedule (ID=1273)

Parameter defines SMS data sending according to week time schedule. This parameter is used to set data sending on selected week days and hours. Minimum time step is 10 minutes.

Example value: 7F,FF,FF,FF,FF,FF,FF,FF,FF,FF,FF,FF,FF,FF,FF,FF,FF,FF,FF,FF

For more information read 8.5.5 "Schedule parameter format".

8.4.13 Authorized phone numbers (ID=1260-1270)

If at least one number is entered then only those number can send messages to device. Number must be entered without "+" or "00".

Example: 37060012346

Minimum value	Maximum value	Recommended value	Goes with (depends on) parameters	Value type
1 digit	16 digits	-		S8[17]

If SMS data sending is enabled (ID=1260) first value in a list is server GSM number. The SMS with 24 coordinates is sent to this number.

8.4.14 SMS Event PreDefined Numbers (ID=150-159)

In this field are written GSM numbers, to which will be sent "Event SMS" text message. Number must be entered without "+" or "00".

Example: 37060012346

Minimum value	Maximum value	Recommended value	Goes with (depends on) parameters	Value type
1 digit	16 digits	-		S8[17]

8.4.15 Operator List (ID=1271 X)

Parameter defines operator list. According to this list module selects operating profile. GSM operator codes are comma separated. First in a list is *Home Operator Code*, then Preferred Roaming Operator Codes are written.

X defines starting position that is changed: If X is from 0 to 49, X means index of operator code which has to be configured. Up to 20 operator codes may be configured in 1 SMS. Example: *setparam 1271 16 24602,24603,24605*

Here 16th, 17th and 18th operator codes are set. Note! Other operator codes are left unchanged in the configuration.

Minimum value	Maximum value	Recommended value	Goes with (depends on) parameters	Value type
Empty	7 digits	-		U32

8.4.16 Black Operator list (ID= 1272 X)

Parameter defines the operator list. X defines the starting position that will be changed: If X is between 0 and 49, X shows the index of the operator code from the blacklist (the operator code has to be previously configured in the list). Up to 20 blacklist operator codes may be configured in 1 SMS. Example: *setparam 1272 16 24602,24603,24605*.

Here 16th, 17th and 18th black operator codes are set. Note! Other operator codes are left unchanged in the configuration.

Minimum value	Maximum value	Recommended value	Goes with (depends on) parameters	Value type
Empty	7 digits	-		U32

8.5 Data Acquisition Modes parameters

8.5.1 Home Network GSM operator code "Vehicle on STOP" parameters

8.5.2 Min Period (ID=1540)

This parameter indicates time interval in seconds in order to acquire new record. If value is 0 it means no records by min period will be saved.

Minimum value	Maximum value	Recommended value	Goes with (depends on) parameters	Value type
0	2592000	-		U32

8.5.3 Min Saved Records (ID=1543)

This parameter defines minimum number of records in one data packet that can be sent to server. It has higher priority than Data Send Period (ID=1544).

Minimum value	Maximum value	Recommended value	Goes with (depends on) parameters	Value type
1	255	1	GPRS Week Time (ID=1545)	U8

8.5.4 Send Period (ID=1544)

This parameter indicates frequency (time interval in seconds) of sending data to server.

Minimum value	Maximum value	Recommended value	Goes with (depends on) parameters	Value type

0	2592000	-	Min Saved Records (ID=1543) GPRS Week Time (ID=1545)	U32
---	---------	---	---	-----

8.5.5 GPRS Week Time (ID=1545)

This parameter manages when it is allowed to open GPRS context. When module starts it is prohibited to open the context. When modem's GPRS context is closing (for example changing network) it is allowed to open it only at a defined time. It is possible to allow connections every 10 minutes up to once per day.

Example value: 7F,FF,FF,FF,FF,FF,FF,FF,FF,FF,FF,FF,FF,FF,FF,FF,FF,FF,FF,FF

Schedule parameter format:

Time is defined as 19 byte array. First byte of array defines week days; the rest 18 bytes define timestamps with 10 minute interval. In first byte, first bit (LSB) defines if module should connect to GPRS (send SMS) on Monday, second bit – on Tuesday and so on up to seventh bit – which means Sunday. Eighth bit (MSB) is not used. If bits value is 0 then device is not allowed to open GPRS context, but if it is already open – does not close it. If value is 1 it will work as day minutes are defined in rest of the bytes. Day's minutes are defined by 18 bytes (144 bits). Every nth bit (beginning from the first bit (LSB) and ending 18 bytes 8th bit (MSB)) indicates every 10th minute of the day (day has 1440 minutes).

Sample: GPRS will be allowed on Monday to Friday at 8:00 and 16:00 GMT. The following value should be configured:

00011111 00000000 00000000 00000000 00000000 00000000 00000000 00000001 00000000 00000000
00000000 00000000 00000000 00000000 00000001 00000000 00000000 00000000 00000000 00000000

Red bits indicate that GPRS will be allowed every day except Saturdays and Sundays. Blue bits indicate 480 and 720 minutes (480min = 8h and 720min = 16h). So the parameter value should be: 1F,00,00,00,00,00,00,01,00,00,00,00,00,01,00,00,00,00,00

It should be sent as UTF8 encoded string.

8.5.6 Home Network GSM operator code "Vehicle MOVING" parameters

8.5.6.1 Min Period (ID=1550)

This parameter indicates time interval in seconds in order to acquire new record. If value is 0 it means no records by min period will be saved.

Minimum value	Maximum value	Recommended value	Goes with (depends on) parameters	Value type
0	2592000	-	Min Distance (ID=1551) Min Angle (ID=1552) Min Speed (ID=1556) GPRS Week Time (ID=1555)	U32

8.5.6.2 Min Distance (ID=1551)

This parameter indicates distance in meters in order to acquire new record. Record is stored when the distance between previous records is greater than parameters value. If value is 0 it means no records by min distance will be saved.

Minimum value	Maximum value	Recommended value	Goes with (depends on) parameters	Value type
0	65535	-	Min Period (ID=1550) Min Angle (ID=1552) Min Speed (ID=1556)	U32

			GPRS Week Time (ID=1555)	
--	--	--	---------------------------------	--

8.5.6.3 Min Angle (ID=1552)

This parameter indicates angle in degrees in order to acquire new record. If angle difference between last recorded coordinate and current position is greater than defined value, new record is stored. This parameter is operational, when speed is higher than 10km/h. If value is 0 it means no records by min angle will be saved.

Minimum value	Maximum value	Recommended value	Goes with (depends on) parameters	Value type
0	180	-	Min Period (ID=1550) Min Distance (ID=1551) Min Speed (ID=1556) GPRS Week Time (ID=1555)	U16

8.5.6.4 Min Saved Records (ID=1553)

This parameter defines minimum number of records in one data packet that can be sent to server. It has higher priority than Data Send Period (ID=1554).

Minimum value	Maximum value	Recommended value	Goes with (depends on) parameters	Value type
1	255	1	Min Period (ID=1550) Min Distance (ID=1551) Min Angle (ID=1552) Min Speed (ID=1556) GPRS Week Time (ID=1555)	U8

8.5.6.5 Send Period (ID=1554)

This parameter indicates frequency (time interval in seconds) of sending data to server.

Minimum value	Maximum value	Recommended value	Goes with (depends on) parameters	Value type
0	2592000	-	GPRS Week Time (ID=1555)	U32

8.5.6.6 GPRS Week Time (ID=1555)

Read 8.5.5.

8.5.6.7 Min Speed (ID=1556)

This parameter indicates speed difference in order to acquire new record. If speed difference between last recorded coordinate and current position is greater than defined value, new record is stored. If value is 0 it means no records by min distance will be saved.

Minimum value	Maximum value	Recommended value	Goes with (depends on) parameters	Value type
0	255	10	Min Period (ID=1550) Min Distance (ID=1551) Min Angle (ID=1552) Min Speed Source (ID=1557)	U16

			GPRS Week Time (ID=1555)	
--	--	--	---------------------------------	--

8.5.6.8 Min Speed Source (ID=1557)

This parameter defines Source for speed difference calculation: 0 – GPS, 1 – LVCAN

Minimum value	Maximum value	Recommended value	Goes with (depends on) parameters	Value type
0	1	0	Min Speed (ID=1556)	U8

8.5.7 Roaming Network GSM operator code “Vehicle on STOP” parameters

8.5.7.1 Min Period (ID=1560)

This parameter indicates time interval in seconds in order to acquire new record. If value is 0 it means no records by min period will be saved.

Minimum value	Maximum value	Recommended value	Goes with (depends on) parameters	Value type
0	2592000	-		U32

8.5.7.2 Min Saved Records (ID=1563)

This parameter defines minimum number of records in one data packet that can be sent to server. It has higher priority than Data Send Period (ID=1564).

Minimum value	Maximum value	Recommended value	Goes with (depends on) parameters	Value type
1	255	1	GPRS Week Time (ID=1565)	U8

8.5.7.3 Send Period (ID=1564)

This parameter indicates frequency (time interval in seconds) of sending data to server.

Minimum value	Maximum value	Recommended value	Goes with (depends on) parameters	Value type
0	2592000	-	Min Saved Records (ID=1563) GPRS Week Time (ID=1565)	U32

8.5.7.4 GPRS Week Time (ID=1565)

Read chapter 8.5.5.

8.5.8 Roaming Network GSM operator code “Vehicle MOVING” parameters

8.5.8.1 Min Period (ID=1570)

This parameter indicates time interval in seconds in order to acquire new record. If value is 0 it means no records by min period will be saved.

Minimum value	Maximum value	Recommended value	Goes with (depends on) parameters	Value type
0	2592000	-	Min Distance (ID=1571) Min Angle (ID=1572)	U32

			Min Speed (ID=1576) GPRS Week Time (1575)	
--	--	--	--	--

8.5.8.2 Min Distance (ID=1571)

This parameter indicates distance in meters in order to acquire new record. Record is stored when the distance between previous records is greater than parameter's value. If value is 0 it means no records by min distance will be saved.

Minimum value	Maximum value	Recommended value	Goes with (depends on) parameters	Value type
0	65535	-	Min Period (ID=1570) Min Angle (ID=1572) Min Speed (ID=1576) GPRS Week Time (1575)	U32

8.5.8.4 Min Angle (ID=1572)

This parameter indicates angle in degrees in order to acquire new record. If angle difference between last recorded coordinate and current position is greater than defined value, new record is stored. This parameter is operational, when speed is higher than 10km/h. If value is 0 it means no records by min angle will be saved.

Minimum value	Maximum value	Recommended value	Goes with (depends on) parameters	Value type
0	180	-	Min Period (ID=1570) Min Distance (ID=1571) Min Speed (ID=1576) GPRS Week Time (1575)	U16

8.5.8.5 Min Saved Records (ID=1573)

This parameter defines minimum number of records in one data packet that can be sent to server. It has higher priority than Data Send Period (ID=1574).

Minimum value	Maximum value	Recommended value	Goes with (depends on) parameters	Value type
1	255	1	Min Period (ID=1570) Min Distance (ID=1571) Min Angle (ID=1572) GPRS Week Time (1575)	U8

8.5.8.6 Send Period (ID=1574)

This parameter indicates frequency (time interval in seconds) of sending data to server.

Minimum value	Maximum value	Recommended value	Goes with (depends on) parameters	Value type
0	2592000	-	Min Saved Records (ID=1573) GPRS Week Time (1575)	U32

8.5.8.7 GPRS Week Time (ID=1575)

Read chapter 8.5.5.

8.5.8.8 Min Speed (ID=1576)

This parameter indicates speed difference in order to acquire new record. If speed difference between last recorded coordinate and current position is greater than defined value, new record is stored. If value is 0 it means no records by min distance will be saved.

Minimum value	Maximum value	Recommended value	Goes with (depends on) parameters	Value type
0	255	10	Min Period (ID=1570) Min Distance (ID=1571) Min Angle (ID=1572) Min Speed Source (ID=1577) GPRS Week Time (ID=1575)	U16

8.5.8.9 Min Speed Source (ID=1577)

This parameter defines Source for speed difference calculation: 0 – GPS, 1 – LVCAN

Minimum value	Maximum value	Recommended value	Goes with (depends on) parameters	Value type
0	1	0	Min Speed (ID=1576)	U8

8.5.9 Unknown Network GSM operator code “Vehicle on STOP” parameters

8.5.9.1 Min Period (ID=1580)

This parameter indicates time interval in seconds in order to acquire new record. If value is 0 it means no records by min period will be saved.

Minimum value	Maximum value	Recommended value	Goes with (depends on) parameters	Value type
0	2592000	-		U32

8.5.9.2 Min Saved Records (ID=1583)

This parameter defines minimum number of records in one data packet that can be sent to server. It has higher priority than Data Send Period (ID=1584).

Minimum value	Maximum value	Recommended value	Goes with (depends on) parameters	Value type
1	255	1	GPRS Week Time (ID=1585)	U8

8.5.9.3 Send Period (ID=1584)

This parameter indicates frequency (time interval in seconds) of sending data to server.

Minimum value	Maximum value	Recommended value	Goes with (depends on) parameters	Value type
0	2592000	-	Min Saved Records (ID=1583) GPRS Week Time (ID=1585)	U32

8.5.9.4 GPRS Week Time (ID=1585)

Read chapter 8.5.5.

8.5.10 Unknown Network GSM operator code “Vehicle MOVING” parameters

8.5.10.1 Min Period (ID=1590)

This parameter indicates time interval in seconds in order to acquire new record. If value is 0 it means no records by min period will be saved.

Minimum value	Maximum value	Recommended value	Goes with (depends on) parameters	Value type
0	2592000	-	Min Distance (ID=1591) Min Angle (ID=1592) Min Speed (ID=1596) Min Speed Source (ID=1597) GPRS Week Time (ID=1595)	U32

8.5.10.2 Min Distance (ID=1591)

This parameter indicates distance in meters in order to acquire new record. Record is stored when the distance between previous records is greater than parameter's value. If value is 0 it means no records by min distance will be saved.

Minimum value	Maximum value	Recommended value	Goes with (depends on) parameters	Value type
0	65535	-	Min Period (ID=1590) Min Angle (ID=1592) Min Speed (ID=1596) GPRS Week Time (ID=1595)	U32

8.5.10.3 Min Angle (ID=1592)

This parameter indicates angle in degrees in order to acquire new record. If angle difference between last recorded coordinate and current position is greater than defined value, new record is stored. This parameter is operational, when speed is higher than 10km/h. If value is 0 it means no records by min angle will be saved.

Minimum value	Maximum value	Recommended value	Goes with (depends on) parameters	Value type
0	180	-	Min Period (ID=1590) Min Distance (ID=1591) Min Speed (ID=1596) GPRS Week Time (ID=1595)	U16

8.5.10.4 Min Saved Records (ID=1593)

This parameter defines minimum number of records in one data packet that can be sent to server. It has higher priority than Data Send Period (ID=1594).

Minimum value	Maximum value	Recommended value	Goes with (depends on) parameters	Value type
1	255	1	Min Period (ID=1590) Min Distance (ID=1591)	U8

			Min Angle (ID=1592) Min Speed (ID=1596) GPRS Week Time (ID=1595)	
--	--	--	---	--

8.5.10.5 Send Period (ID=1594)

This parameter indicates frequency (time interval in seconds) of sending data to server. In order to send data to server GPRS parameters must be enabled

Minimum value	Maximum value	Recommended value	Goes with (depends on) parameters	Value type
0	2592000	-	Min Saved Records (ID=1593) GPRS Week Time (ID=1595)	U32

8.5.10.6 GPRS Week Time (ID=1595)

Read chapter 8.5.5.

8.5.10.7 Min Speed (ID=1596)

This parameter indicates speed difference in order to acquire new record. If speed difference between last recorded coordinate and current position is greater than defined value, new record is stored. If value is 0 it means no records by min distance will be saved.

Minimum value	Maximum value	Recommended value	Goes with (depends on) parameters	Value type
0	255	1	Min Period (ID=1590) Min Distance (ID=1591) Min Angle (ID=1592) Min Speed Source (ID=1597) GPRS Week Time (ID=1595)	U16

8.5.10.8 Min Speed Source (ID=1597)

This parameter defines Source for speed difference calculation: 0 – GPS, 1 – LVCAN

Minimum value	Maximum value	Recommended value	Goes with (depends on) parameters	Value type
0	1	0	Min Speed (ID=1596)	U8

8.6 Features Parameters

8.6.1 Green driving scenario (ID=1890)

This parameter lets enable/disable Green driving scenario. 0 – disable, 1 – enable.

Minimum value	Maximum value	Recommended value	Goes with (depends on) parameters	Value type
0	1	-		U8

8.6.2 Green Driving digital output control (ID=1891)

This parameter defines digital output control on Green Driving scenario. 0 – disable, 1 – DOUT1, 2 – DOUT2.

Minimum value	Maximum value	Recommended value	Goes with (depends on) parameters	Value type
0	2	-	Green driving scenario (ID=1890)	U8

8.6.3 Max Acceleration Force (ID=1892)

It is max allowed acceleration force which can be reached while accelerating without triggering harsh acceleration event.

Minimum value	Maximum value	Recommended value	Goes with (depends on) parameters	Value type
0.25	0.85	0.25	Green driving scenario (ID=1890)	Float

8.6.4 Max Braking Force (ID=1893)

It is max allowed braking force which can be reached while braking without triggering harsh braking event.

Minimum value	Maximum value	Recommended value	Goes with (depends on) parameters	Value type
0.25	0.85	0.35	Green driving scenario (ID=1890)	Float

8.6.5 Max Cornering Force (ID=1894)

It is max allowed cornering force which can be reached while cornering without triggering harsh cornering event.

Minimum value	Maximum value	Recommended value	Goes with (depends on) parameters	Value type
0.1	1.0	0.3	Green driving scenario (ID=1890)	U16

Reference for Max Cornering Force values:

- 0,4 - 0,45 G force – items that are left on the back seat start to slide to the side while the car is on turn;
- 0,75 – 0,95 G force – most of the cars loose grip on turn (normal environment conditions).

8.6.6 Overspeeding scenario (ID=1895)

This parameter enables/disables Overspeeding scenario. 0 – disable, 1 – enable.

Minimum value	Maximum value	Recommended value	Goes with (depends on) parameters	Value type
0	1	-		U8

8.6.7 Over Speeding digital output control (ID=1896)

This parameter defines digital output control on Overspeeding scenario. 0 – disable, 1 – DOUT1, 2 – DOUT2.

Minimum value	Maximum value	Recommended value	Goes with (depends on) parameters	Value type
0	2	-	Overspeeding scenario (ID=1895)	U8

8.6.8 Max allowed speed (ID=1897)

This parameters defines max allowed speed on Overspeeding scenario.

Minimum value	Maximum value	Recommended value	Goes with (depends on) parameters	Value type
0	260	-	Overspeeding scenario (ID=1895)	U8

8.6.9 Jamming scenario (ID=1898)

This parameter enables/disables Jamming scenario. 0 – disable, 1 – enable.

Minimum value	Maximum value	Recommended value	Goes with (depends on) parameters	Value type
0	1	-		U8

8.6.10 Jamming digital output control (ID=1899)

This parameter defines digital output control on Jamming scenario. 0 – disable, 1 – DOUT1, 2 – DOUT2.

Minimum value	Maximum value	Recommended value	Goes with (depends on) parameters	Value type
0	2	-	Jamming scenario (ID=1899)	U8

8.6.11 Jamming sensitivity (ID=1900)

This parameter defines Jamming sensitivity. 0 – low sensitivity (50 RSSI), 1 – medium sensitivity (30 RSSI), 2 – high sensitivity (10 RSSI).

Minimum value	Maximum value	Recommended value	Goes with (depends on) parameters	Value type
0	3	-	Jamming scenario (ID=1899)	U8

8.6.12 Jamming Timeout (ID=1901)

This parameter represents DOUT turning on timeout when jamming is detected.

Minimum value	Maximum value	Recommended value	Goes with (depends on) parameters	Value type
0	65535	60	Jamming scenario (ID=1899) Jamming digital output control (ID=1899)	U16

8.6.13 Jamming Pulse duration (ID=1902)

This parameter defines the Jamming Pulse duration after which DOUT is turned on.

Minimum value	Maximum value	Recommended value	Goes with (depends on) parameters	Value type
0	65535	0	Jamming scenario (ID=1899) Jamming digital output control (ID=1899)	U16

8.6.14 Immobilizer scenario (ID=1903)

This parameter lets enable/disable Immobilizer scenario. 0 – disable, 1 – enable.

Minimum value	Maximum value	Recommended value	Goes with (depends on) parameters	Value type
0	1	-		U8

8.6.15 Immobilizer digital output control (ID=1904)

This parameter defines digital output control on Immobilizer scenario. 0 – disable, 1 – DOUT1, 2 – DOUT2.

Minimum value	Maximum value	Recommended value	Goes with (depends on) parameters	Value type
0	2	-	Immobilizer scenario (ID=1903)	U8

8.6.16 iButton list checking (ID=1905)

This parameter enables/disables iButton list checking. 0 – disable, 1 – enable.

Minimum value	Maximum value	Recommended value	Goes with (depends on) parameters	Value type
0	1	-	Immobilizer scenario (ID=1903) iButtons list (ID=1610-1659)	U8

8.6.17 Trip (ID=1280)

This parameter enables ability to detect START and STOP of the trip.

Minimum value	Maximum value	Recommended value	Goes with (depends on) parameters	Value type
0	1	-		U8

8.6.18 Start Speed (ID=1281)

This parameter represents speed, which is detected as minimum speed to indicate TRIP START and generate event.

Minimum value	Maximum value	Recommended value	Goes with (depends on) parameters	Value type
0	255	-	Trip (ID=1280)	U8

8.6.19 Ignition Off Timeout (ID=1282)

This parameter represents timeout to wait if ignition is off in order to detect TRIP STOP and generate event.

Minimum value	Maximum value	Recommended value	Goes with (depends on) parameters	Value type
0	65535	-	Trip (ID=1280)	U16

8.6.20 Trip Continuous distance counting (ID=1283)

For this feature I/O#11 Trip distance must be enabled. If I/O Trip distance is enabled, and Continuous distance counting variable is set to Continuous (value 1), TRIP distance is going to be counted continuously (from TRIP start to TRIP stop) and shown as I/O Trip distance value.

Minimum value	Maximum value	Recommended value	Goes with (depends on) parameters	Value type
0	1	-	Trip (ID=1280) I/O#11 – Trip distance (ID = 1410-1415)	U8

8.6.21 Remember iButton ID (ID=1284)

This parameter enables/disables Remember iButton ID functionality. 0 – disable, 1 – enable.

Minimum value	Maximum value	Recommended value	Goes with (depends on) parameters	Value type
0	1	-	Trip (ID=1280) iButton List (ID=1610-1659)	U8

8.6.22 Odometer value (ID=1285)

This parameter represents start odometer value.

Minimum value	Maximum value	Recommended value	Goes with (depends on) parameters	Value type
0	-	-	I/O#27 – Total distance (ID=1130-1135)	U8

8.6.23 Geofencing

In this chapter it is explained how to get all parameters for the first Geofence zone (all ID numbers are for the 1st zone). And at the end of the chapter (part 8.6.10) is presented a table with the IDs of all the rest Geofence zones.

8.6.23.1 Frame border (ID=1020)

Geofence border thickness, measured in meters.

Minimum value	Maximum value	Recommended value	Goes with (depends on) parameters	Value type
0	1000000	1000	All Geofencing parameters	U32

8.6.23.2 Geofence Zone #1 Shape (ID=1030)

Geofence shape parameter can be: circle – value 0; rectangle – value 1.

Minimum value	Maximum value	Recommended value	Goes with (depends on) parameters	Value type
0	1	-	All Geofencing parameters	U8

8.6.23.3 Geofence Zone #1 Priority (ID=1031)

Parameter defines Geofence priority: 0 is low, 1 – high, 2 – panic;

Minimum value	Maximum value	Recommended value	Goes with (depends on) parameters	Value type
0	2	-	All Geofencing parameters	U8

8.6.23.4 Geofence Zone #1 Generate Event (ID=1032)

Generate event on:

- a) No event – value 0
- b) On entering zone – value 1;
- c) On exiting zone – value 2;
- d) On both – value 3;

Minimum value	Maximum value	Recommended value	Goes with (depends on) parameters	Value type
0	3	-	All Geofencing parameters	U8

8.6.23.5 Geofence Zone #1 Longitude (X1) (ID=1033)

Parameter has two meanings dependent on zone shape. If shape is a rectangle, then ID=1033 is left down corner X coordinate. If shape is a circle, then ID=1033 is center of that circle X coordinate.

Sample value: 25.30528

Minimum value	Maximum value	Recommended value	Goes with (depends on) parameters	Value type
-180	180	-	All Geofencing parameters	Float

8.6.23.6 Geofence Zone #1 Latitude (Y1) (ID=1034)

Parameter has two meanings dependent on zone shape. If shape is a rectangle, then ID=1034 is left down corner Y coordinate. If shape is a circle, then ID=1034 is center of that circle Y coordinate.

Minimum value	Maximum value	Recommended value	Goes with (depends on) parameters	Value type
-90	90	-	All Geofencing parameters	Float

8.6.23.7 Geofence Zone #1 Longitude (X2) (ID=1035)

Parameter has two meanings depending on zone shape. If shape is a rectangle, then ID=1035 is right upper corner X coordinate. If shape is a circle, then ID=1035 is radius of circle with center of ID=1033 and ID=1034.

For rectangle:

Minimum value	Maximum value	Recommended value	Goes with (depends on) parameters	Value type
-180	180	-	All Geofencing parameters	Float

For circle:

Minimum value	Maximum value	Recommended value	Goes with (depends on) parameters	Value type
0	1000000	1000	All Geofencing parameters	Float

8.6.23.8 Geofence Zone #1 Latitude (Y2) (ID=1036)

If shape is rectangular, then ID=1036 is right upper corner Y coordinate. If shape circle, ID=1036 is not used.

Minimum value	Maximum value	Recommended value	Goes with (depends on) parameters	Value type

-90	90	-	All Geofencing parameters	Float
-----	----	---	----------------------------------	-------

Other 4 GeoFence zone's parameters have the same logic as shown in GeoFence Zone #1.

GeoFence Zone Number	Geofence Zone's parameters
1	1030-1036
2	1040-1046
3	1050-1056
4	1060-1066
5	1070-1076

8.6.24 AutoGeofencing

8.6.24.1 Enable/Disable (ID=1101)

Enable – value 1; disable – value 0;

Minimum value	Maximum value	Recommended value	Goes with (depends on) parameters	Value type
0	1	1		U8

8.6.24.2 Activation Timeout (ID=1102)

Parameter represents AutoGeofencing activation timeout in seconds.

Minimum value	Maximum value	Recommended value	Goes with (depends on) parameters	Value type
0	65535	60	Enable/Disable (ID=1101)	U16

8.6.24.3 Deactivate by (ID=1100)

Parameter defines Autogeofence deactivation source. Value 1 is dedicated for attached iButton, value 0 – for Ignition.

Minimum value	Maximum value	Recommended value	Goes with (depends on) parameters	Value type
0	1	-	Enable/Disable (ID=1101) iButton List (ID=1610-1659)	U8

8.6.24.4 AutoGeofence event Priority (ID=1103)

Parameter defines AutoGeofence event priority: 0 is low, 1 – high;

Minimum value	Maximum value	Recommended value	Goes with (depends on) parameters	Value type
0	1	1	Enable/Disable (ID=1101) AutoGeofence event generating (ID=1104)	U8

8.6.24.5 AutoGeofence event generating (ID=1104)

Generate event: 0 – no event, 1 – on entering zone; 2 – on exiting zone; 3 – on both;

Minimum value	Maximum value	Recommended value	Goes with (depends on) parameters	Value type

0	3	2	Enable/Disable (ID=1101) AutoGeofence event Priority (ID=1103)	U8
---	---	---	--	----

8.6.24.6 Radius (ID=1105)

Parameter represents radius of circle with center device coordinates after activating AutoGeofence feature.

Minimum value	Maximum value	Recommended value	Goes with (depends on) parameters	Value type
0	1000000	100	Enable/Disable (ID=1101) Deactivate by (ID=1100)	U32

8.6.25 iButton List (ID=1610-1659)

Read 5.4.4.

Minimum value	Maximum value	Recommended value	Goes with (depends on) parameters	Value type
0	FFFFFFFF FFFFFFFF	-	Immobilizer scenario (ID=1903) iButtons list checking (ID=1905)	U64

8.7 I/O parameters

I/O properties are additional data sources which are recorded along with usual GPS data.

8.7.1 I/O#1 property parameter (ID=1300)

Parameter defines I/O property value. Possible values: enabled (1), disabled (0).

Minimum value	Maximum value	Recommended value	Goes with (depends on) parameters	Value type
0	1	-	I/O#1 priority (ID=1301) I/O#1 High level (ID=1302) I/O#1 Low level (ID=1303) I/O# logic operand (ID=1304) I/O#1 Averaging length (ID=1305)	S8

8.7.2 I/O#1 priority (ID=1301)

Parameter defines I/O property type of priority: 0 is low, 1 – high, 2 – panic.

Minimum value	Maximum value	Recommended value	Goes with (depends on) parameters	Value type
0	2	0	I/O#1 property parameter (ID=1300) I/O#1 High level (ID=1302) I/O#1 Low level (ID=1303) I/O# logic operand (ID=1304) I/O#1 Averaging length (ID=1305)	S8

8.7.3 I/O#1 High level (ID=1302)

Parameter defines high value of triggered I/O property. This parameter is used to set thresholds for I/O properties to generate events.

Minimum value	Maximum value	Recommended value	Goes with (depends on) parameters	Value type
-2147483647	2147483647	1	I/O#1 property parameter (ID=1300) I/O#1 priority (ID=1301) I/O#1 Low level (ID=1303) I/O# logic operand (ID=1304) I/O#1 Averaging length (ID=1305)	S32

8.7.4 I/O#1 Low level (ID=1303)

Parameter defines low value of triggered I/O property. This parameter is used to set thresholds for I/O properties to generate events.

Minimum value	Maximum value	Recommended value	Goes with (depends on) parameters	Value type
-2147483647	2147483647	0	I/O#1 property parameter (ID=1300) I/O#1 priority (ID=1301) I/O#1 High level (ID=1302) I/O# logic operand (ID=1304) I/O#1 Averaging length (ID=1305)	S32

8.7.5 I/O#1 logic operand (ID=1304)

Parameter defines when event is sent: 0 – on range exit, 1 – on range entrance, 2 – both, 3 – monitoring, 4 – hysteresis, 5 – on changes.

Minimal value	Maximum value	Recommended value	Goes with (depends on) parameters	Value type
0	4	3	I/O#1 property parameter (ID=1300) I/O#1 priority (ID=1301) I/O#1 High level (ID=1302) I/O# Low level (ID=1303) I/O#1 Averaging length (ID=1305)	S8

8.7.6 I/O#1 averaging length (ID=1305)

Parameter defines I/O property sample length to average. If no averaging needed default value is 1.

Minimum value	Maximum value	Recommended value	Goes with (depends on) parameters	Value type
0	2592000	1	I/O#1 property parameter (ID=1300) I/O#1 priority (ID=1301) I/O#1 High level (ID=1302) I/O# Low level (ID=1303) I/O#1 Logic operand (ID=1304)	S32

Other I/O property elements can be configured in same logic. All I/O element parameters are listed in the next table.

I/O Element Number	I/O element parameters
Digital Input 1	1300-1305
Digital Input 2	1310-1315
Digital Input 3	1320-1325
Analog Input 1	1330-1335
Digital Output 1	1340-1345
Digital Output 2	1350-1355
GNSS PDOP	1360-1365
GNSS HDOP	1370-1375
External Voltage	1380-1385
GNSS Power	1390-1395
Movement Sensor	1400-1405
Trip Distance	1410-1415
GSM Operator	1420-1425
Speed (Km/h)	1430-1435
iButton ID	1440-1445
Mode	1450-1455
GSM Signal	1460-1465
Deep Sleep	1470-1475
Cell ID	1480-1485
Area Code	1490-1495
Dallas Temperature 1	1500-1505
Reserved	1510-1515
Reserved	1520-1525
Reserved	1530-1535
Reserved	1110-1115
Ignition	1120-1125
Total Distance	1130-1135
Reserved IO1	1140-1145
Reserved IO2	1150-1155
RFID	1160-1165
LLS Fuel1	1720- 1725
LLS Temp1	1730- 1735
LLS Fuel2	1740- 1745
LLS Temp2	1750- 1755
LLS Fuel3	1760- 1765
LLS Temp3	1770- 1775
LLS Fuel4	1780- 1785
LLS Temp4	1790- 1795
LLS Fuel5	1800- 1805
LLS Temp5	1810- 1815
Dallas Temperature 2	1830- 1835

Dallas Temperature 3	1850- 1855
Dallas Temperature 4	1870- 1875
Dallas Temperature ID 1	1820- 1825
Dallas Temperature ID 2	1840- 1845
Dallas Temperature ID 3	1860- 1865
Dallas Temperature ID 4	1880- 1885

SMS event configuration

8.7.7 I/O#1 element SMS event configuration (ID=100)

Command sets SMS warning on I/O#1 element.

SMS Format: setparam X Y,W,Z

X – ID

Y – Enable/Disable (1/0)

W – Telephone number INDEX (See **8.4.18 SMS Event Predefined Numbers** paragraph, ID 150 – INDEX 0; ID151 – INDEX 1, ...)

Z – SMS Text

Example: “setparam 100 1,5,Digital Input 1 Event!”

Other I/O element SMS events can be configured in same logic. All I/O element SMS event IDs are listed in the next table.

LV-CAN200 is configured

Element name (default SMS Event Text)	ID
Digital input 1	100
Digital input 2	101
Digital input 3	102
Analog input1	103
Digital output 1	104
Digital output 2	105
GNSS PDOP	106
GNSS HDOP	107
External voltage	108
GNSS Status	109
Movement sensor	110
Trip distance	111
GSM operator code	112
Speed	113
iButton ID	114
Data mode	115
GSM signal	116
Deep Sleep	117
GSM Cell ID (CID)	118
GSM Location Area Code (LAC)	119

Dallas Temperature 1	120
Digital input 4	121
Analog input 2	122
Battery voltage	123
Battery current	124
Ignition	125
Total distance	126
Reserved for future use	127
Reserved for future use	128
LVCAN Speed	129
LVCAN Accelerator pedal position	130
LVCAN Total fuel used	131
LVCAN Fuel level (liters)	132
LVCAN Engine RPM	133
LVCAN Vehicle distance	134
LVCAN Fuel level (proc.)	135
LVCAN Program number	136
Green Driving	137
Overspeeding	138
Jamming detection	139
Immobilizer	140
Trip	141
Geofence 1	142
Geofence 2	143
Geofence 3	144
Geofence 4	145
Geofence 5	146
AutoGeofence	147

ALL-CAN300 configured

Element name (default SMS Event Text)	ID
Digital input 1	100
Digital input 2	101
Digital input 3	102
Analog input1	103
Digital output 1	104
Digital output 2	105
GNSS PDOP	106
GNSS HDOP	107
External voltage	108
GNSS Status	109
Movement sensor	110
Trip Distance	111
GSM operator code	112
Speed	113

iButton ID	114
Data mode	115
GSM signal	116
Deep Sleep	117
GSM Cell ID (CID)	118
GSM Location Area Code (LAC)	119
Dallas Temperature 1	120
Digital input 4	121
Analog input 2	122
Battery voltage	123
Battery current	124
Ignition	125
Total distance	126
Reserved for future use	127
Reserved for future use	128
LVCAN Vehicle Speed	129
LVCAN Accelerator pedal position	130
LVCAN Fuel Consumed	131
LVCAN Fuel level (liters)	132
LVCAN Engine RPM	133
LVCAN Total Mileage	134
LVCAN Fuel level (percent)	135
LVCAN Program number	136
Green Driving	137
Overspeeding	138
Jamming detection	139
Immobilizer	140
Trip	141
Geofence 1	142
Geofence 2	143
Geofence 3	144
Geofence 4	145
Geofence 5	146
AutoGeofence	147
LVC ModuleID	210
LVC Engine Work time	211
LVC Engine Work time(counted)	212
LVC Total Mileage (counted)	213
LVC Fuel Consumed (counted)	214
LVC Fuel Rate	215
LVC AdBlue Level (percent)	216
LVC AdBlue Level (liters)	217
LVC Engine Load	218
LVC Engine Temperature	219
LVC Axle 1 Load	220
LVC Axle 2 Load	221

LVC Axle 3 Load	222
LVC Axle 4 Load	223
LVC Axle 5 Load	224
LVC Control State Flags	225
LVC Agricultural Machinery Flags	226
LVC Harvesting Time	227
LVC Area of Harvest	228
LVC Mowing Efficiency	229
LVC Grain Mown Volume	230
LVC Grain Moisture	231
LVC Harvesting Drum RPM	232
LVC Gap Under Harvesting Drum	233
LVC Security State Flags	234
LVC Tacho Total Vehicle Distance	235
LVC Trip Distance	236
LVC Tacho Vehicle Speed	237
LVC Tacho Driver Card Presence	238
LVC Driver1 States	239
LVC Driver2 States	240
LVC Driver1 Continuous Driving Time	241
LVC Driver2 Continuous Driving Time	242
LVC Driver1 Cumulative Break Time	243
LVC Driver2 Cumulative Break Time	244
LVC Driver1 Duration Of Selected Action	245
LVC Driver2 Duration Of Selected Action	246
LVC Driver1 Cumulative Driving Time	247
LVC Driver2 Cumulative Driving Time	248
RFID	250
LLS Fuel1	251
LLS Temp1	252
LLS Fuel2	253
LLS Temp2	254
LLS Fuel3	255
LLS Temp3	256
LLS Fuel4	257
LLS Temp4	258
LLS Fuel5	259
LLS Temp5	260
LVC Driver1 ID High	262
LVC Driver1 ID Low	263
LVC Driver2 ID High	264
LVC Driver2 ID Low	265
LVC Battery Temperature	266
LVC Battery Level	267
LVC Door Status	268
LVC Reserved	269

Dallas Temperature 2	270
Dallas Temperature 3	271
Dallas Temperature 4	272
Dallas Temperature 1 ID	273
Dallas Temperature 2 ID	274
Dallas Temperature 3 ID	275
Dallas Temperature 4 ID	276

8.8 LV-CAN parameters

8.8.1 LVCAN mode (ID=1600)

This parameter sets LVCAN/ALLCAN detection, available values: 0 – Auto Detect, 1 – LVCAN200, 2 – ALLCAN300.

Minimum value	Maximum value	Recommended value	Goes with (depends on) parameters	Value type
0	2	0		U8

8.8.2 Send data with 0, if ignition is off (ID=1601)

This parameter enables/disables data sending with 0 value, if ignition is off. 0 – disable, 1 – enable.

Minimum value	Maximum value	Recommended value	Goes with (depends on) parameters	Value type
0	1	1		U8

9 FMA110 with LV-CAN200 and ALL-CAN300 Can Adapters

9.1 Purpose of Can Adapters LV-CAN200 and ALL-CAN300

LV-CAN200 is used to listening data from light vehicles, while ALL-CAN300 is used to listening data from any type of transport: light vehicles, Trucks, busses, agriculture and other special transport. With those adapters FMA110 device is able to collect and send vehicle data.

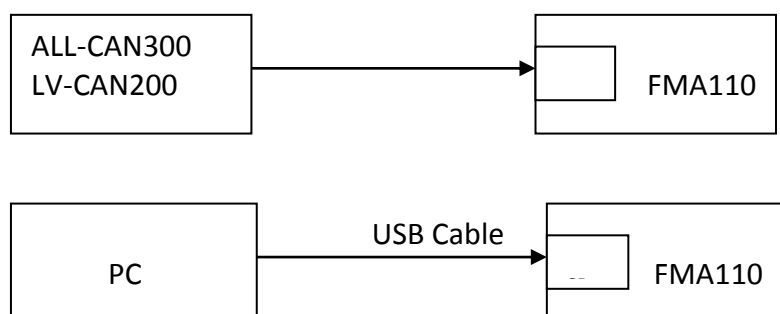

Figure 53 connection block diagram

FMA110 shares the same USB port for connecting adapter and configuring device with PC.

LV-CAN200 and ALL-CAN300 Technical characteristics:

PARAMETER	VALUE
Supply voltage	9 to 50V
Power supply current	Average 10mA Max (peak) 100mA
Working temperature	-40..85 °C
Max working humidity	60 % (non condensate)

9.2 LV-CAN200 and ALL-CAN300 program number selection

LV-CAN200 or ALL-CAN300 must be set to program number which depends on vehicle model. **Needed program number is always written on LV-CAN200 or ALL-CAN300 mounting scheme.** Please contact Your Teltonika sales manager to get latest supported vehicle list and mounting scheme for your vehicle, please provide CAR manufacturer, model and year information.

9.2.1 LV-CAN200 and ALL-CAN300 program number configuration via SMS command

LV-CAN200 and ALL-CAN300 program number can be set remotely, using SMS command:

lvcansetprog X

X is new program number value.

9.2.2 Selecting LV-CAN200 and ALL-CAN300 program number manually

Steps to set program number:

- Hold SWITCH down till LED starts blinking
- Release the SWITCH
- Then LED starts blinking and counting first digit of program number, (one blink means digit 1, two blink digit 2 etc.)
- To stop counter push SWITCH
- Release the SWITCH, then LED starts blinking and counting second digit of program number
- To stop counter push SWITCH
- Release the SWITCH, then LED starts blinking and counting third digit on program number

- To stop counter push SWITCH
- Release SWITCH, if programming is succeeded LED will blink 10 times



Figure 54 Adapter signaling led

9.3 SIMPLE-CAN - contactless CAN-BUS reader

SIMPLE-CAN is contactless adapter used to read vehicle CAN data with LV-CAN200, ALL-CAN300. If LV-CAN200 or ALL-CAN300 connection requires two CAN lines to get all data, then you need two SIMPLE-CAN readers

TECHNICAL DETAILS

- Power supply voltage 9-63 V
- Power supply current:

Mode	12V	24V
Active	8.3 mA	4.3 mA
Standby	1.6 mA	0.91 mA
- CAN-BUS speeds from 33,33 to 500 kb/s
- Automatically sets CAN Low, CAN High polarity
- Automatically adjusts signal level and speed

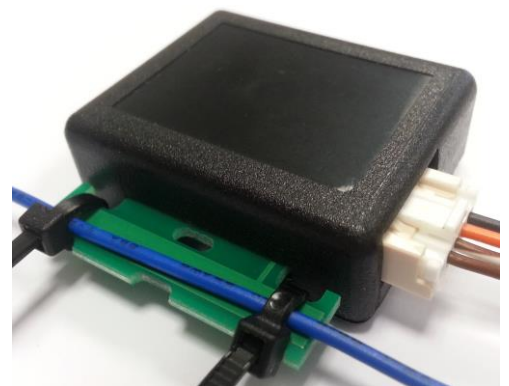

SIMPLE-CAN works in the **listening mode only**, so not all the data available on the CAN-BUS may be received using this solution. **The device automatically sets CAN L/H polarity**, but the calibration has to be always executed during installation process. Connection of previously calibrated unit to another car needs new calibration because the reader **automatically adjusts**

signal level and speed to different CAN-BUSES. The device also **automatically adapts to the found noise level.**

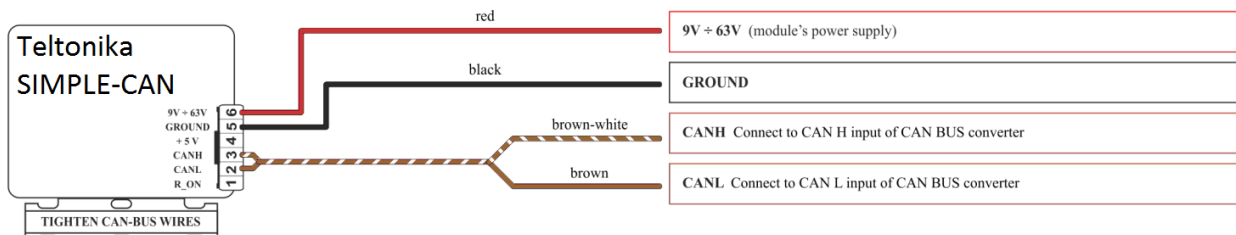

Figure 55 Simple CAN connection

After power supply connecting, LED shines continuously. It means that device awaits for calibration. **Calibration process** has to be carried out when CAN-BUS twisted pair is tightened on SIMPLE-CAN and when the ignition is ON. Please press the switch shortly and wait for the LED to start blinking every 1 second. Automatic calibration process takes up to 10 seconds depending on the vehicle's model. Correct calibration process is confirmed by LED's every 2 seconds blink (when the CAN-BUS is active). When the CAN-BUS enters sleep mode, SIMPLE-CAN device does it also and takes 1,6mA/12V. In the sleep mode LED does not shine. If after calibration process LED shines continuously, it means that device is not calibrated yet, CAN-BUS transmission has failed or ignition during calibration was not ON.

9.4 Connecting FMA110 Can adapters ALL-CAN300 and LV-CAN200

Connect USB Plug to FMA110 device, connect Light Vehicles Can adapter to other end of the cable.

Connect Light Vehicles Can adapter Pin 1 and Pin 2 to cars CAN bus. CAN interface location of the supported light vehicle is described on mounting scheme.

Connect car power supply lines to Pin 3 positive, Pin 4 Negative.

Pins 9,10 connection is optional it depends on exact car model.

For exact pinout see sticker on Light Vehicles Can adapter.

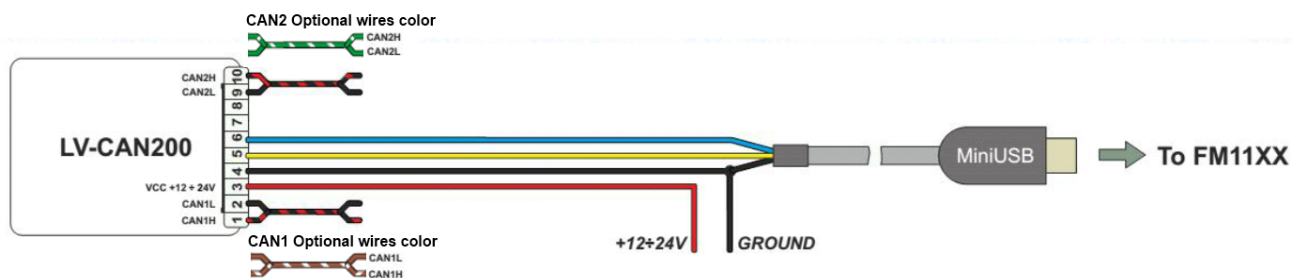

Figure 55 LV-CAN200 Adapter connection cable pinout

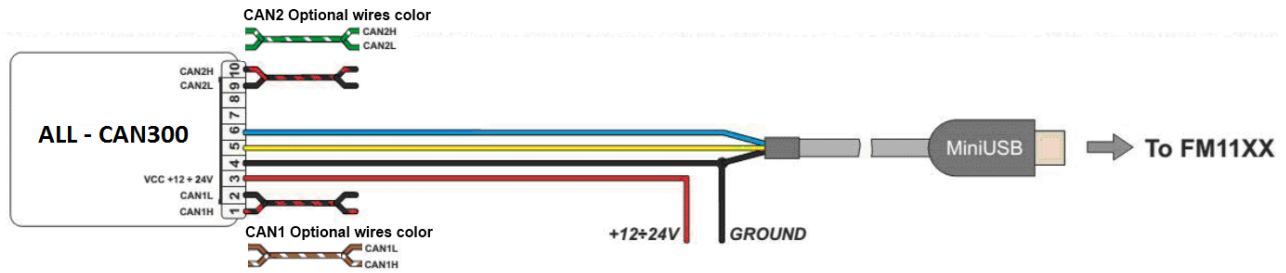

Figure 56 ALL-CAN300 Adapter connection cable pinout



Attention! For detailed connection diagram of adapter to light vehicle please contact Teltonika, LTD sales representative and provide CAR manufacturer, model and year information.



Attention! Do not swap CAN L and CAN H lines.
Do not swap power supply lines. Make sure that voltage do not exceeds 30V.
Power supply lines should be connected at the end of installation work.

9.5 FM11 Configuration

FMA110 shares the same USB port for connecting LV-CAN200 or ALL-CAN300 adapter and configuring device with PC.

FMA110 can be configured using “SCAN” function or “Offline Configuration”

SCAN function – is in use when FMA110 is connected to CAN adapter (Figure 57), then wait 10s (Note, that car engine must be started), disconnect adapter from FMA110, and connect PC USB cable to FMA110 Device (Figure 57). It is very important not to disconnect FMA110 from power source during this operation, because if FMA110 is reconnected all received CAN bus data will be lost. FMA110 remembers received data from LV-CAN200 or ALL-CAN300 and at the end of the procedure when “SCAN” button is pressed, user will see all CAN data which is sent by adapter. Enable CAN data which needs send to server and save configuration pressing “Save” button.

To configure CAN data:

1. In car, connect LV-CAN200 or ALL-CAN300 to CAN bus and to the FMA110 device (Figure 57), wait 10 seconds. Note, that car engine must be started.
2. Disconnect LV-CAN200 or ALL-CAN300 from FMA110, and connect PC USB cable to FMA110 Device (Figure 58). It is very important not to disconnect FMA110 from power source, because then all CAN data will be lost.

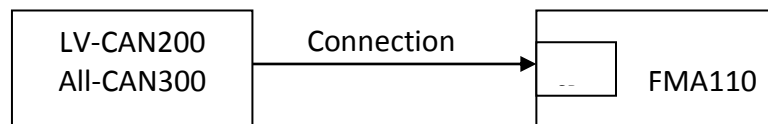

Figure 57 Connect adapter LV-CAN100 to FMA110

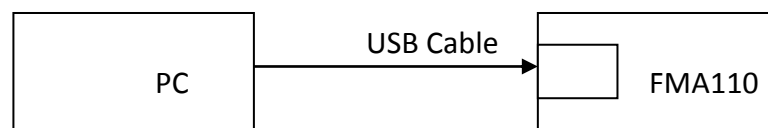

Figure 58 Connect FMA110 to PC and configure

CAN bus data which can be read from your car is shown in “Light or ALL Vehicles Can adapter supported cars” document.

Offline configuration – user can select which CAN data will be red from LV-CAN200 or ALL-CAN300 and directly sent to server without connection to adapter. Please note that parameters depend on vehicle manufacturer and vehicle model. Please for further information check “Light and All Vehicles Can adapter supported cars” document.

There are two types of operations with CAN data elements:

- Monitoring of CAN bus data
- CAN bus data event capturing

Monitoring method is used when user wants to receive CAN data on regular basis, for example every 20 seconds.

Event functionality is used to store additional AVL packet when state of CAN element is changing. For example Speed changes, low fuel level, engine temperate, etc.

Send data to server field – allows enabling CAN element so it is added to the AVL data packet and sent to the server. By default, all CAN elements are disabled and FMA110 records only GPS data.

It is possible to set CAN message priority: On Low Priority, On High Priority, and On Panic. Regular packets are sent as Low priority records. When low priority event is triggered, FMA110 makes additional record with indication what was the reason for that was CAN element change. When High priority is selected, module makes additional record with high priority flag and sends event packet immediately to the server by GPRS. Panic priority triggers same actions as high priority, but if GPRS fails, it sends AVL packet to server using SMS mode if SMS is enabled in SMS settings.

Data Acquisition Type – defines when to generate event – when value enters defined range, exits it or both, also is possible to select event which you want to generate then you change values, like crossing both values in high and low levels (Hysteresis).

High and Low levels – defines CAN value range. If CAN value enter or exits this range, FMA110 generates event by “Data Acquisition Type” settings. Figure 59 show example of FMA110 CAN configuration.

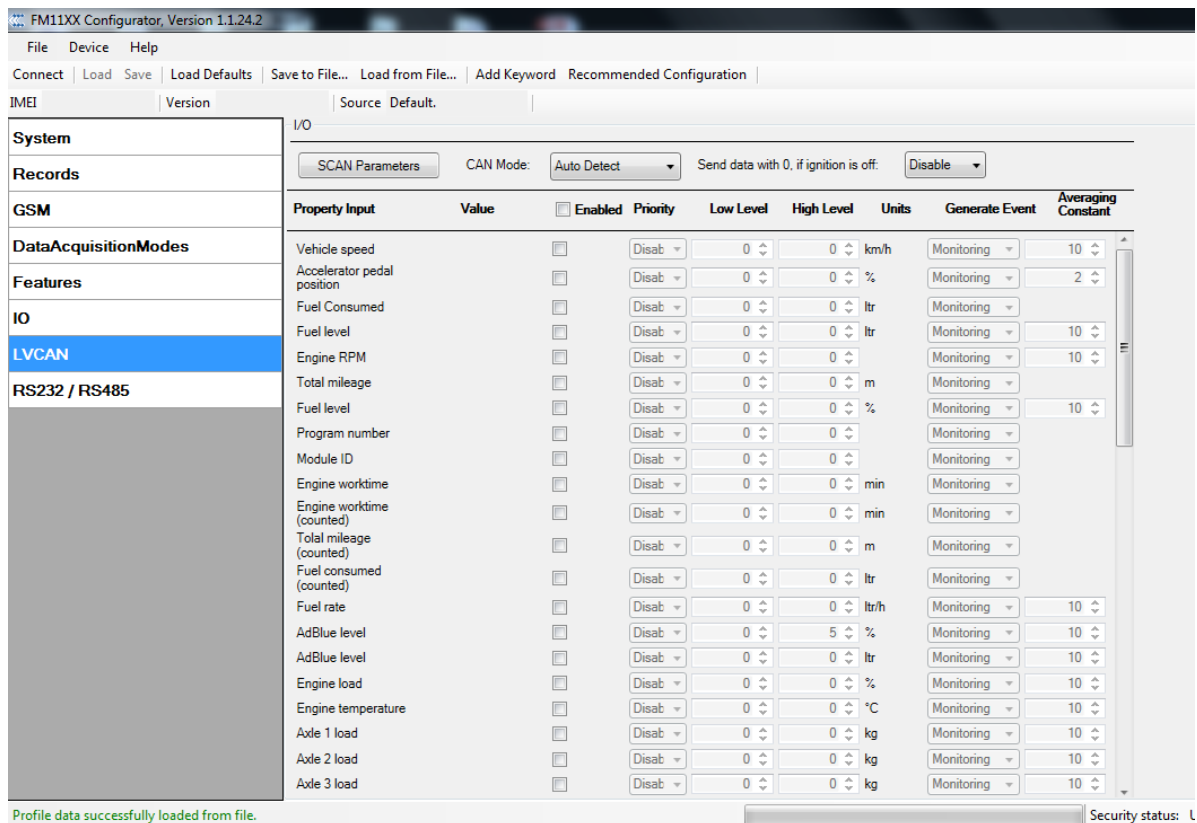

Figure 59 Configurator example

Available CAN Bus IO parameters and configuration can be found in Configurators LVCAN tab (Figure 59) and in next chapter “Parameters ID”.

Send data with 0, if ignition is off. Depending on LVCAN/ALLCAN I/O parameters and ignition status, FMA110 can send *locked* (last known) LVCAN/ALLCAN I/O parameters values, *reset* values (set to 0) and *active* (real time) parameters values. When ignition is off, LVCAN/ALLCAN I/O parameters values sent to server are:

Speed	reset
Accelerator pedal position	reset
Total fuel used	lock
Fuel level (liters)	lock
Engine RPM	reset
Total mileage	lock
Fuel level (proc.)	lock
Program number	lock
Module ID	lock
Engine Work Time	lock
Engine Work Time (counted)	lock
Total Mileage (counted)	lock
Fuel Consumed (counted)	lock
Fuel Rate	reset

AdBlue Level (percent)	lock
AdBlue Level (liters)	lock
Engine Load	reset
Engine Temperature	active
Axle 1 Load	lock
Axle 2 Load	lock
Axle 3 Load	lock
Axle 4 Load	lock
Axle 5 Load	lock
Control State Flags	active
Agricultural Machinery Flags	active
Harvesting Time	lock
Area of Harvest	reset
Mowing Efficiency	active
Grain Mown Volume	active
Grain Moisture	active
Harvesting Drum RPM	reset
Gap Under Harvesting Drum	active
Security State Flags	active
Tachograph Total Vehicle Distance	lock
Trip Distance	reset
Tachograph Vehicle Speed	reset
Tachograph Driver Card Presence	active
Driver1 States	active
Driver2 States	active
Driver1 Continuous Driving Time	active
Driver2 Continuous Driving Time	active
Driver1 Cumulative Break Time	active
Driver2 Cumulative Break Time	active
Driver1 Selected Activity Duration	active
Driver2 Selected Activity Duration	active
Driver1 Cumulative Driving Time	active
Driver2 Cumulative Driving Time	active

Parameters ID

When no I/O element is enabled, AVL packet comes with GPS information only. After enabling I/O element(s) AVL packet along with GPS information contains current value(s) of

enabled I/O element. AVL packet decoding is described in “FMXXX Protocols” document. List of available CAN bus data, parameter size, ID and value range you can find in table 9.1 and 9.2.

Table 9.1 ACQUIRED LV- CAN200 PARAMETRS IO ID

Category name	Param index	(signal) name	Size (Bytes)	Param IO ID	Value range
65265 – Cruise Control/Vehicle Speed	0	Vehicle Speed	1	81	0-250 km/h
61443 – Electronic Engine Controller #2	1	Accelerator Pedal Position	1	82	0-100 %
65257 – Fuel Consumption	2	Total Fuel Used	4	83	0-99999999 liters*
65276 – Dash Display	3	Fuel Level [liters]	2	84	0-255 liters
61444 – Electronic Engine Controller #1	4	Engine RPM	2	85	0-8200 rpm
65217 – High Resolution Vehicle Distance	5	Vehicle Distance	4	87	0-2145000000 meters
65276 – Dash Display	6	Fuel Level [%]	1	89	0-100 %
Program number	7	LV-CAN200 Program number	4	100	0-999

NOTE:

„Total Fuel Used“ is sent to server multiplied by 10.

Example: if value was 150.5 liters, „1505“ will be sent to server.

Table 9.2 ACQUIRED ALL-CAN300 PARAMETRS IO ID

Property Input	Param index	Size (Bytes)	Param IO ID	Measurement units	a1	Remarks
ALL-CAN300 Program number	29	4	100	-	-	
Module ID	30	8	101	-	-	
Engine Work Time	31	4	102	min	1	
Engine Work Time (counted) *	32	4	103	min	1	
Total Mileage	33	4	87	meters	1	
Total Mileage (counted) *	34	4	105	meters	1	
Fuel Consumed	35	4	83	Ltr * 10	0.1	
Fuel Consumed (counted) *	36	4	107	Ltr * 10	0.1	
Fuel Level [%]	37	1	89	proc.*	1	
Fuel Level [liters]	38	2	84	Ltrs * 10	0.1	
Fuel Rate	39	2	110	(Ltrs * 10) / h	0.1	
AdBlue Level	40	1	111	proc.	1	

(percent)						
AdBlue Level (liters)	41	2	112	Ltrs * 10	0.1	
Engine RPM	42	2	85	-	1	
Engine Load	43	1	114	proc.	1	Valid range: 0 – 125%
Engine Temperature	44	1	115	°C x 10	0.1	signed
Accelerator Pedal Position	45	1	82	proc.	1	
Vehicle Speed	46	1	81	km/h	1	
Axle 1 Load	47	2	118	kg	1	
Axle 2 Load	48	2	119	kg	1	
Axle 3 Load	49	2	120	kg	1	
Axle 4 Load	50	2	121	kg	1	
Axle 5 Load	51	2	122	kg	1	
Control State Flags	52	4	123	-	-	see table 9.2.1
Agricultural Machinery Flags	53	8	124	-	-	see table 9.2.1
Harvesting Time	54	4	125	min	1	
Area of Harvest	55	4	126	m ²	1	
Mowing Efficiency	56	4	127	m ² /h	1	
Grain Mown Volume	57	4	128	kg	1	
Grain Moisture	58	2	129	proc.	1	
Harvesting Drum RPM	59	2	130	-	-	
Gap Under Harvesting Drum	60	1	131	mm	1	
Security State Flags	61	8	132	-	-	see table 9.2.1
Tacho Total Vehicle Distance	62	4	133	m	1	
Trip Distance	63	4	134	m	1	
Tacho Vehicle Speed	64	2	135	km/h	1	
Tacho Driver Card Presence	65	1	136	-	-	see table 9.2.1
Driver1 States	66	1	137	-	-	see table 9.2.1
Driver2 States	67	1	138	-	-	see table 9.2.1
Driver1 Continuous Driving Time	68	2	139	min	1	
Driver2 Continuous Driving Time	69	2	140	min	1	
Driver1 Cumulative Break Time	70	2	141	min	1	
Driver2 Cumulative	71	2	142	min	1	

Break Time						
Driver1 Duration Of Selected Activity	72	2	143	min	1	
Driver2 Duration Of Selected Activity	73	2	144	min	1	
Driver1 Cumulative Driving Time	74	2	145	min	1	
Driver2 Cumulative Driving Time	75	2	146	min	1	
Driver1 ID High	76	8	147	ASCII		
Driver1 ID Low	77	8	148	ASCII		
Driver2 ID High	78	8	149	ASCII		
Driver2 ID Low	79	8	150	ASCII		
Battery Temperature	80	2	151	°C x 10	0.1	signed
Battery Level (percent)	81	1	152	proc.	1	

NOTE:

„Total Fuel Used“ is sent to server multiplied by 10.

Example: if value was 150.5 liters, „1505“ will be sent to server.

Table 9.2.1 ALLCAN300 IO element values

Idx	Description	Size, Bytes	AVL ID	Value bitmasks
52	Control state flags	4	123	<p>Byte0 (LSB):</p> <ul style="list-style-type: none"> 0x01 – STOP 0x02 – Oil pressure / level 0x04 – Coolant liquid temperature / level 0x08 – Handbrake system 0x10 – Battery charging 0x20 – AIRBAG <p>Byte1:</p> <ul style="list-style-type: none"> 0x01 – CHECK ENGINE 0x02 – Lights failure 0x04 – Low tire pressure 0x08 – Wear of brake pads 0x10 – Warning 0x20 – ABS 0x40 – Low Fuel <p>Byte2:</p> <ul style="list-style-type: none"> 0x01 – ESP 0x02 – Glow plug indicator 0x04 – FAP 0x08 – Electronics pressure control 0x10 – Parking lights 0x20 – Dipped headlights 0x40 – Full beam headlights <p>Byte3:</p> <ul style="list-style-type: none"> 0x40 – Passenger's seat belt

				0x80 – Driver's seat belt
53	Agricultural machinery flags	8	124	<p>Byte0 (LSB):</p> <ul style="list-style-type: none"> 0x01 – Mowing 0x02 – Grain release from hopper 0x04 – First front hydraulic turned on 0x08 – Rear Power Take-Off turned on <p>Byte1:</p> <ul style="list-style-type: none"> 0x01 – Excessive play under the threshing drum 0x02 – Grain tank is open 0x04 – 100% of Grain tank 0x08 – 70% of Grain tank 0x10 – Drain filter in hydraulic system of drive cylinders is plugged 0x20 – Pressure filter of drive cylinders hydraulic system is plugged 0x40 – Alarm oil level in oil tank 0x80 – Pressure filter of brakes hydraulic system is plugged <p>Byte2:</p> <ul style="list-style-type: none"> 0x01 – Oil filter of engine is plugged 0x02 – Fuel filter is plugged 0x04 – Air filter is plugged 0x08 – Alarm oil temperature in hydraulic system of chasis 0x10 – Alarm oil temperature in hydraulic system of drive cylinders 0x20 – Alarm oil pressure in engine 0x40 – Alarm coolant level 0x80 – Overflow chamber of hydraulic unit <p>Byte3:</p> <ul style="list-style-type: none"> 0x01 – Unloader drive is ON. Unloading tube pivot is in idle position 0x02 – No operator! 0x04 – Straw walker is plugged 0x08 – Water in fuel 0x10 – Cleaning fan RPM 0x20 – Trashing drum RPM <p>Byte4:</p> <ul style="list-style-type: none"> 0x02 – Low water level in the tank 0x04 – First rear hydraulic turned on 0x08 – Standalone engine working 0x10 – Right joystick moved right 0x20 – Right joystick moved left 0x40 – Right joystick moved front 0x80 – Right joystick moved back <p>Byte5:</p> <ul style="list-style-type: none"> 0x01 – Brushes turned on 0x02 – Water supply turned on 0x04 – Vacuum cleaner

				<p> 0x08 – Unloading from the hopper 0x10 – High Pressure washer (Karcher) 0x20 – Salt (sand) disperser ON 0x40 – Low salt (sand) level Byte6: 0x01 – Second front hydraulic turned on 0x02 – Third front hydraulic turned on 0x04 – Fourth front hydraulic turned on 0x08 – Second rear hydraulic turned on 0x10 – Third rear hydraulic turned on 0x20 – Fourth rear hydraulic turned on 0x40 – Front three-point Hitch turned on 0x80 – Rear three-point Hitch turned on Byte7: 0x01 – Left joystick moved right 0x02 – Left joystick moved left 0x04 – Left joystick moved front 0x08 – Left joystick moved back 0x10 – Front Power Take-Off turned on </p>
61	Security state flags	8	132	<p> Byte0 (LSB): 0x20 – bit appears when any operate button in car was put 0x40 – bit appears when immobilizer is in service mode 0x80 – immobiliser, bit appears during introduction of a programmed sequence of keys in the car. Byte1: 0x01 – the key is in ignition lock 0x02 – ignition on 0x04 – dynamic ignition on 0x08 – webasto 0x20 – car closed by factory's remote control 0x40 – factory-installed alarm system is actuated (is in panic mode) 0x80 – factory-installed alarm system is emulated by module Byte2: 0x01 – parking activated (automatic gearbox) 0x10 – handbrake is actuated (information available only with ignition on) 0x20 – footbrake is actuated (information available only with ignition on) 0x40 – engine is working (information available only when the ignition on) 0x80 – revers is on Byte3: 0x01 – Front left door opened 0x02 – Front right door opened 0x04 – Rear left door opened 0x08 – Rear right door opened 0x10 – engine cover opened 0x20 – trunk door opened </p>

				Byte4: 0x01 – car was closed by the factory's remote control 0x02 – car was opened by the factory's remote control 0x03 – trunk cover was opened by the factory's remote control 0x04 – module has sent a rearming signal 0x05 – car was closed three times by the factory's remote control - High nibble (mask 0xF0 bit) 0x80 – CAN module goes to sleep mode
65	Tachograph driver card presence	1	136	0x00 – No driver card 0x01 – Driver1 card presence 0x02 – Driver2 card presence 0x03 – Driver1 and driver2 cards present
66	Driver 1 states	1	137	0xX0 – break/rest 0xX1 – availability 0xX2 – work 0xX3 – driving 0x0X – no time-related warning detected 0x1X – limit #1: 15 min before 4 1/2 h 0x2X – limit #2: 4 1/2 h reached (continuous driving time exceeded) 0x3X – limit #3: 15 minutes before optional warning 1 0x4X – limit #4: optional warning 1 reached 0x5X – limit #5: 15 min before optional warning 0x6X – limit #6: optional warning 2 reached
67	Driver 2 states	1	138	

9.6 SMS Configuration

CAN Bus IO elements can be configured remotely via SMS command. First ID number is always '2', seconds ID number is always '0'. Third ID number refers to specific LV-CAN200 or ALL-CAN300 IO element (table 9.3). And the last ID number refers to sections – Property; Generation Type; Low and High levels (Table 9.4).

Here's example:

ID 2013 – configures Accelerator Pedal position parameter “High Level”.

Table 9.3 LV-CAN200 and ALL-CAN300 IO elements SMS configuration Ids range

ALL-CAN300 and LV-CAN200 IO Elements	Parameter Ids range
Speed	2000-2004
Accelerator pedal position	2010-2014
Total fuel used	2020-2023
Fuel level (liters)	2030-2034
Engine RPM	2040-2044
Total mileage	2050-2053
Fuel level (proc.)	2060-2064

Program number	2070-2073
Module ID	2080-2083
Engine Work Time	2090-2093
Engine Work Time (counted)	2100-2103
Total Mileage (counted)	2110-2113
Fuel Consumed (counted)	2120-2123
Fuel Rate	2130-2134
AdBlue Level (percent)	2140-2144
AdBlue Level (liters)	2150-2154
Engine Load	2160-2164
Engine Temperature	2170-2174
Axle 1 Load	2180-2184
Axle 2 Load	2190-2194
Axle 3 Load	2200-2204
Axle 4 Load	2210-2214
Axle 5 Load	2220-2224
Control State Flags	2230-2233
Agricultural Machinery Flags	2240-2243
Harvesting Time	2250-2253
Area of Harvest	2260-2263
Mowing Efficiency	2270-2274
Grain Mown Volume	2280-2283
Grain Moisture	2290-2294
Harvesting Drum RPM	2300-2304
Gap Under Harvesting Drum	2310-2314
Security State Flags	2320-2323
Tachograph Total Vehicle Distance	2330-2333
Trip Distance	2340-2343
Tachograph Vehicle Speed	2350-2354
Tachograph Driver Card Presence	2360-2363
Driver1 States	2370-2373
Driver2 States	2380-2383
Driver1 Continuous Driving Time	2390-2393
Driver2 Continuous Driving Time	2400-2403
Driver1 Cumulative Break Time	2410-2413
Driver2 Cumulative Break Time	2420-2423
Driver1 Selected Activity Duration	2430-2433
Driver2 Selected Activity Duration	2440-2443
Driver1 Cumulative Driving Time	2450-2453
Driver2 Cumulative Driving Time	2460-2463
Door status	2530-2534
LVCAN reserved	2540-2544

Table 9.4 LV-CAN200 and ALL-CAN300 IO parameters configuration

Parameter ID	Parameter name	Available values
2xx0	Priority	0 – IO element disabled 1 – Low priority 2 – High priority 3 – Panic priority

2xx1	Generation type	0 – Event on exit 1 – Event on entrance 2 – Event on both 3– Monitoring 4 – Hysteresis 5 – On change
2xx2	Low level	See table 9.5 – Allowed Values From 0 to 2 ³²
2xx3	High Level	
2xx4	Averaging Constant	

Table 9.5 LV-CAN200 and ALL-CAN300 IO parameters allowed values

LV-CAN200 IO Element	Minimum value	Maximum value
Speed	0	250
Accelerator pedal position	0	100
Total fuel used	0	99999999
Fuel level (liters)	0	100
Engine RPM	0	8200
Vehicle distance	0	2145000000
Fuel level (proc.)	0	100
Program number	0	999

9.7 CAN Program Number request by SMS

CAN program number can be obtained via SMS:

SMS Text: "lvcangetprog"

Response: "CAN Program Nr: XXX"

9.8 Get CAN info by SMS

Full LV-CAN information via SMS:

SMS Text: "lvcangetinfo"

Response:

"Prog: 139

SWRevison: 6

KernVer: 10

KernVar: 49

MdIID: 8884443332221110"

9.9 Clear counted parameters value

It is possible to clear Total Mileage (counted), Engine Work Time (counted), Fuel Consumed (counted) parameters with following SMS command.

SMS text: "lvcancel x"

Possible values of x:

0 – Engine work time (counted);

1 – Fuel Consumed (counted);

2 – Vehicle Mileage (counted);

10 MOUNTING RECOMMENDATIONS

10.1 Connecting Wires

- Wires should be connected while module is not plugged in.
- Wires should be fastened to the other wires or non-moving parts. Try to avoid heat emitting and moving objects near the wires.
- The connections should not be seen very clearly. If factory isolation was removed while connecting wires, it should be applied again.
- If the wires are placed in the exterior or in places where they can be damaged or exposed to heat, humidity, dirt, etc., additional isolation should be applied.
- Wires cannot be connected to the board computers or control units.

10.2 Connecting Power Source

- Be sure that after the car computer falls asleep, power is still available on chosen wire. Depending on car, this may happen in 5 to 30 minutes period.
- When module is connected, be sure to measure voltage again if it did not decrease.
- It is recommended to connect to the main power cable in the fuse box.

10.3 Connecting Ignition Wire

- Be sure to check if it is a real ignition wire – power does not disappear while starting the engine.
- Check if this is not an ACC wire (when key is in the first position, most electronics of the vehicle are available).
- Check if power is still available when you turn off any of vehicles devices.
- Ignition is connected to the ignition relay output. As alternative, any other relay, which has power output, when ignition is on, may be chosen.

10.4 Connecting Ground Wire

- Ground wire is connected to the vehicle frame or metal parts that are fixed to the frame.
- If the wire is fixed with the bolt, the loop must be connected to the end of the wire.
- For better contact scrub paint from the place where loop is connected.



PAY ATTENTION! Connecting the power supply must be carried out in a very low impedance point on-board vehicle network. These points in the car are the battery terminals. Therefore, we recommend connecting the power of FMA110 (wire GND and POWER) directly to the battery terminals. Another valid option is to connect the wires to the main POWER cable inside the fuse box (if there is none, then to the power supply where the fuses of vehicle's computer are), wire GND must be connected in a special point, designed to connect GND vehicle computer. Connecting the GND at an arbitrary point to the mass of the car is unacceptable, as static and dynamic potentials on the line GND will be unpredictable, which can lead to unstable FMA110 and even its failure.

10.5 Module Installation

- FMA110 must be placed sticker on TOP (please refer picture below).
- It's forbidden to place FMA110 under metal surfaces.
- It's recommended to place FMA110 device far from car radio, speakers or alarm systems.
- FMA110 must be placed so its state is as horizontal as possible.
- FMA110 should not be seen or easily reached.
- FMA110 should be firmly fixed to the surface or cables.
- FMA110 cannot be fixed to heat emitting or moving parts.
- SIM card should be inserted in the module while the connector is plugged off (while module has no power).

It is recommended to place FMA110 device behind dashboard as close to the window as possible. A good example of device placement is displayed in a picture below.

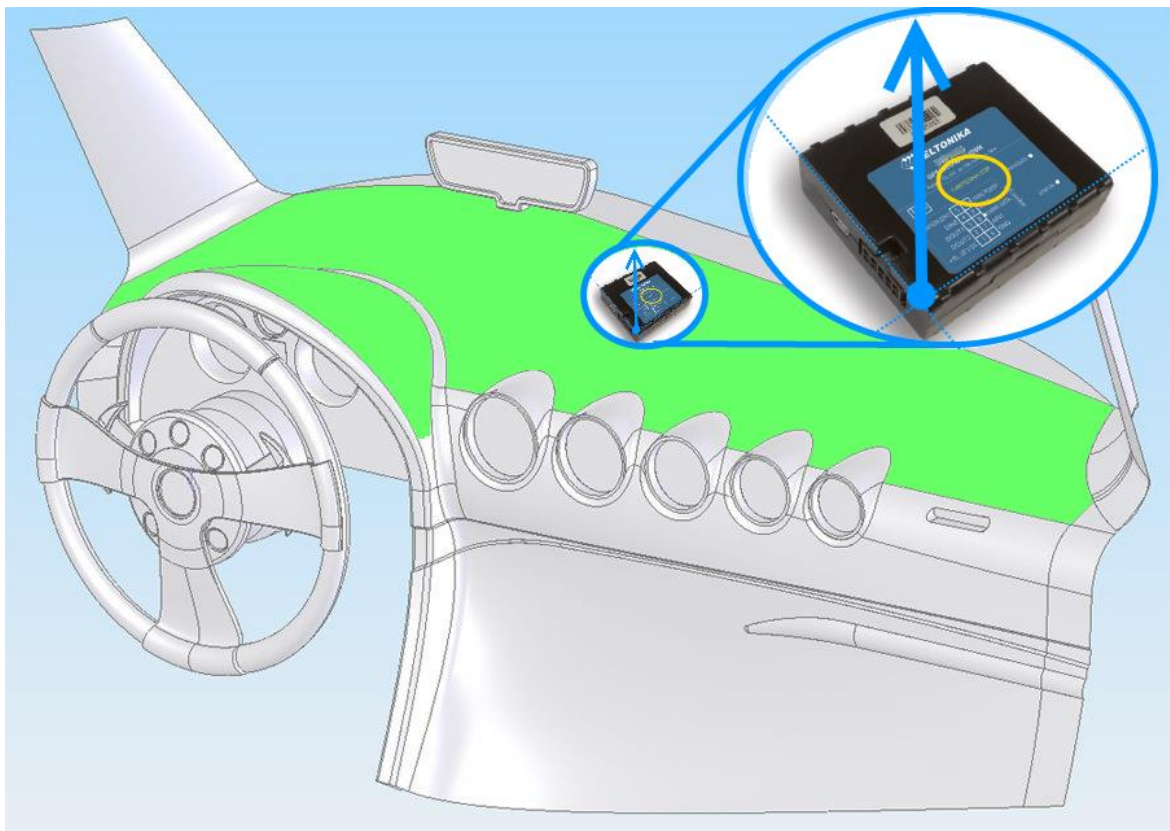

Figure 24 Correct placement of FMA110

11 CHANGE LOG

Nr.	Date	Version	Comments
1	2016-10-26	1.00	Preliminary draft release.
2	2016-12-29	1.01	ALLCAN AVL IDs fixed, consumption table updated
3	2017-02-02	1.02	“Setdigout” command description updated
4	2017-02-16	1.03	Simple CAN description added
5	2017-03-20	1.04	<p>New version release for new base firmware 01.24.xx</p> <p>Always online mode description added, ID added; Black operator list description and IDs added; Scenarios: Green driving, Overspeeding, Jamming detection, Immobilizer descriptions and IDs updated; Continuous odometer description added; Remember iButton functionality description added; New I/O element 16 Total distance (Virtual odometer) added; setdigoutX Z Y description added; GNSS fix Timeout parameter ID added; Parameter “Odometer value” name was changed to “Trip distance”; Added 4 TTJ ID I/O elements, “getcontsens” command added; LVCAN description updated: Send data with 0, if ignition is off; new I/O elements: Door Status detection and Reserved for future use added; Reference Max Cornering Force values description added.</p>
6	2017-04-06	1.05	Minor changes
7	2017-04-07	1.06	<p>Trip distance (ID=1285) renamed to Odometer value (ID=1285); I/O GPS power description updated.</p>